G O S S

JANUARY 8, 2001

**Government
Office
Space
Standards**

Province of British Columbia

1.0	INTRODUCTION	3
1.1	BACKGROUND & PURPOSE	3
1.2	GOVERNMENT OFFICE SPACE STANDARDS APPLICATION	3
1.3	INTEGRATED WORKPLACE STRATEGIES APPLICATION	3
1.4	REPORT STRUCTURE.....	3
2.0	STRATEGIC PRINCIPLES.....	5
2.1	CORE PRINCIPLES	5
2.2	OPERATING PRINCIPLES	5
2.3	COST CONTAINMENT PRINCIPLES	6
3.0	CREATING INNOVATIVE SPACE SOLUTIONS	7
3.1	INTRODUCTION TO INTEGRATED WORKPLACE STRATEGIES (IWS).....	7
3.2	THE IWS PLANNING PROCESS.....	7
	Figure 1: IWS Planning Process.....	9
	Figure 2: Planning Options Matrix.....	10
3.3	ON SITE OPTIONS	12
3.4	OFF SITE OPTIONS.....	13
4.0	PROCESS AND DOCUMENTATION	15
4.1	INTRODUCTION	15
4.2	PROCESS FLOW	15
	Figure 3: Functional Space Requirements – Sample Workbook Page.....	16
4.3	FUNCTIONAL SPACE REQUIREMENTS – WORKBOOK INSTRUCTIONS.....	17
	Figure 4: Functional Space Requirements – Instruction Notes.....	18
5.0	PEOPLE SPACE ALLOCATIONS.....	19
5.1	SPACE ALLOCATION – FUNCTIONAL SPACE REQUIREMENTS FOR INDIVIDUAL WORKSPACES	19
	Figure 5: Footprint Sizes and Criteria.....	19
5.2	SPACE TYPE A – OPEN WORKSTATION 4.5M ² 50FT ²	20
5.3	SPACE TYPE B – OPEN AREA 6.5M ² 70FT ²	21
5.4	SPACE TYPE C – OPEN 9.3M ² 100FT ²	22
5.5	SPACE TYPE D – ENCLOSED AREA 11.15M ² 120FT ²	23
5.6	SPACE TYPE E – ENCLOSED AREA 13.9M ² 150FT ²	24
5.7	SPACE TYPE F – ENCLOSED AREA 22.5M ² 240FT ²	25
5.8	FUNCTIONAL SPACE REQUIREMENTS MATRIX.....	26
6.0	SUPPORT SPACE ALLOCATIONS.....	29
6.1	SUPPORT SPACE FIVE STAGE ANALYSIS	29
	Table 1: Furniture and Equipment.....	30
	Table 2: Break Areas.....	31
	Table 3: Meeting & Training Room Total Allocation.....	31
	Table 3a: Meeting Room Size Guidelines.....	31
	Figure 6: Meeting Area 11.15 m ²	32
	Figure 7: Meeting Area 13.90 m ²	33
	Figure 8: Meeting Area 16.70 m ²	34
	Figure 9: Meeting Area 22.30 m ²	35
	Table 4: Data & Telecommunications.....	36
	Table 5: Washroom, Shower and Change Room Facilities.....	37
	Table 6: Building Common Support Spaces.....	38
6.2	SPACE PLANNING PRINCIPLES.....	39
7.0	MARK-UP FACTORS	41
7.1	SPACE AREA DEFINITIONS	41
7.2	CIRCULATION SPACE FACTORS.....	42
	Table 7: Circulation Allowance Calculations.....	42

7.3	DETERMINING THE BUILDING LOSS FACTOR.....	43
	Table 8: Determining Building Loss Factors.....	43
7.4	APPLICATION OF MARK-UP FACTORS.....	44
	Table 9: Markup Factors.....	44
APPENDIX A – GLOSSARY.....		45
APPENDIX B – MINISTRY SPECIFIC STANDARDS		49
APPENDIX C – OUTLINE OF TECHNICAL STANDARDS.....		51
APPENDIX D – APPLICATION FOR ENCLOSED OFFICES.....		53
APPENDIX E – IWS REFERENCES & SUGGESTED READINGS		57
APPENDIX F – MARK-UP FACTORS DIAGRAMS.....		59
	Figure 10: Rentable Area.....	59
	Figure 11: BOMA Useable Area – Single Tenancy.....	60
	Figure 12: Occupiable.....	61
	Figure 13: BCBC Useable Area – Multiple or Single Tenancy.....	62

1.1 Background & Purpose

This document provides standards for the size of government office spaces. The intent of these standards is to ensure equity and consistency in the provision of government office space. Resultant office space should meet users' functional space requirements and be cost-effective. Ministries, with the aid of the BC Buildings Corporation (BCBC), are committed to reduce both capital and operating costs.

The *Government Office Space Standards* (GOSS) were prepared by the Space Standards Subcommittee of the Client Panel. Working groups of this Subcommittee reviewed all of the following information: guiding principles, documentation and process, benchmarking, integrated workplace strategies (IWS), workstations and enclosed office numbers and sizes, support space measurement and markup factors.

Client Panel and Space Standards Subcommittee comprised of:

**Provincial Government Ministries
British Columbia Buildings Corporation**

1.2 Government Office Space Standards Application

These standards are to be applied to the upgrading, changing, or new development of any government office accommodation. Deviations from *Government Office Space Standards* are at the discretion of the deputy minister or designate. These standards do not apply to non-office facilities such as warehouses and institutional properties. Along with *Government Office Space Standards*, BCBC has developed several related standards and guidelines, such as Technical Standards for Offices (refer to Appendix C- Outline of Technical Standards).

1.3 Integrated Workplace Strategies Application

The total space allocated by GOSS is to be considered as a maximum space allowance or envelope. Planning within this envelope can be done in a traditional fashion and/or utilizing *integrated workplace strategies* (IWS). Clients are encouraged to utilize integrated workplace strategies to ensure their functional needs are met in the most effective manner within their allocated space envelope. **Clients who adopt IWS approaches that reduce workstation sizes or number required shall not have their overall space envelope reduced unless they are in agreement.**

1.4 Report Structure

- Section 2 outlines the Core Principles, Operating Principles, Cost Containment Principles, and Planning Principles
- Section 3 outlines Integrated Workplace Strategies (IWS)
- Section 4 outlines the process for Functional Space Requirements, including a sample "workbook" and detailed instructions
- Section 5 outlines People Space Allocations for individual workspaces
- Section 6 outlines Support Space Allocations and Space Planning Principles for government offices
- Section 7 outlines Mark-up Factors

----- **end of section 1** -----

The development and application of the *Government Office Space standards* will be guided by Core Principles, Operating Principles, Cost Containment Principles, and Planning Principles as follows.

2.1 Core Principles

<i>Employee Support</i>	Employees will be treated equitably and provided with healthy, safe and accessible office workplaces.
<i>Program Support</i>	Office workplaces will be designed to support effective program delivery.
<i>Value for Money</i>	Maximizing value for money will be a goal of all facilities decisions.
<i>Cost-Containment</i>	Cost-containment strategies, such as re-use of existing tenant improvements, will be applied to all projects.
<i>Responsibility for Conformance</i>	Ministries and BCBC are jointly responsible for applying these standards to all projects.
<i>Clarity & Simplicity</i>	Standards will be clear and concise. Associated processes will be simple and easy to understand and implement.

2.2 Operating Principles

<i>Space Allocation & Entitlement</i>	GOSS does not 'entitle' staff to specific workstation sizes. It is a method of determining the overall requirements of a group and a method for determining how that space is allocated. Actual individual space allocations are determined on the basis of functional space requirements, the priorities of the organization, and the total space and budget available.
<i>Open Workstations</i>	In general, employees of the Province of British Columbia shall be provided with open area accommodation. Enclosed offices will be provided for staff functions requiring a high degree of unscheduled confidentiality, either from other staff within their own group or visiting public within the office. Based on functional justification, these enclosed spaces may be single occupant offices, shared discussion/meeting rooms, interview rooms, wicket space and/or other space types.
<i>Anticipating Change</i>	Space plans will anticipate organizational or workstation pattern changes by having fewer types of workstations and more flexible layouts. Furniture and screen purchases shall support anticipating change and flexibility by incorporating the following features: free standing, mobile, modular, and flexible.
<i>Building Quality / Appearance</i>	Building quality for new construction will be governed by cost containment strategies and BCBC's Technical Standards.

2.3 Cost Containment Principles

- Space Savings Strategies* Space savings can be achieved from the use of efficient layouts, space saving equipment, and recovery of unused space. Implementation of Integrated Workplace Strategies (IWS) also generally results in space savings.
- Collocation* Ministries are encouraged to seek partnerships and co-locations with other ministries and governments with a view to sharing facilities, equipment, furniture and resources.
- Move People, Not Furniture* Staff with similar functional needs will move to a different workstation with similar furniture and functionality, rather than move an entire workstation when occupants or work patterns change. Also known as a "Briefcase Move".
- Re-Use Existing Tenant Improvements* Existing tenant improvements and assets will be re-used/ re-furnished wherever practical. New tenant improvements will not be permitted in short term leases (three years or less) except for health and safety issues or where they can be cost-justified for operational reasons.
- Expansion Space* Space allocations will be determined based on existing staffing levels. No allowance will be made for projected growth unless ministries have specific approval by the Deputy Minister.

----- **end of section 2** -----

3.1 Introduction to Integrated Workplace Strategies (IWS)

Changing Workplace Generally in North America, the workplace is in transition.

Technology is more powerful, portable, and integrated allowing greater flexibility in work productivity and location.

Increasingly, the workplace is no longer seen as a central office or building but rather as a set of spaces and tools which enable the worker and enhance the work process. The new workplace needs to accommodate teams as well as individuals and support employees who are increasingly mobile, require flexibility and use portable technology.

Integrated Workplace Strategies

Approaches to accommodating work which encompasses more than just how and where people work. Ideally, it should also include work processes, human resources and technology. Management support is critical for the development and implementation of such new concepts and policies.

Benefits of IWS

Management and empowered employees searching for innovative ways to improve their organization's effectiveness are focusing their attention on workplace strategies that support the worker, enhance productivity, and minimize the cost of accommodation.

3.2 The IWS Planning Process

Government is encouraged to move beyond the traditional options of the past when creating a new workplace. The IWS Process Chart (Figure 1) illustrates a typical process when exploring IWS. The four steps include:

1. Assemble Criteria & Define Strategic Objective(s)
2. Evaluate Each Strategy in Terms of Goals & Objectives
3. Determine Solution (may be multi-strategy)
4. Continue to Monitor, Evaluate & Modify

To create an effective new environment, those responsible for the design and planning of space must have a thorough understanding of an organization's structure, strategic goals and changing management practices. Significant knowledge about the individual users and the work process is essential. With this information the planning process can begin to take shape. Planning solutions should reflect this understanding in the provision of a workplace that supports how and where people work.

The implementation of different strategies involves the full participation of the users in developing the concepts with total support by management. An IWS approach requires a willingness to evaluate and question existing work processes, adequate lead-time and resources. The resultant strategies not only enable people to achieve their maximum effectiveness, but often the consequence is increased efficiency, more flexible layouts, and reduced space requirements.

The strategies can be considered as a continuum. The most conservative and commonly applied approach maintains the traditional one-person-one-workspace ratio but reduces the size of individual workspaces to free up space for team meeting areas and project rooms. In the most radical solution, the traditional office is either replaced by full-time telecommuting or by the virtual office in which the workplace can be anywhere. In between these extremes, a number of alternatives exist which allow for long-term flexibility.

This process allows for an opportunity to utilize a wide variety of on and off-site strategies. Solutions typically involve an integrated combination of strategies and need to be customized for each project.

Figure 1: IWS Planning Process

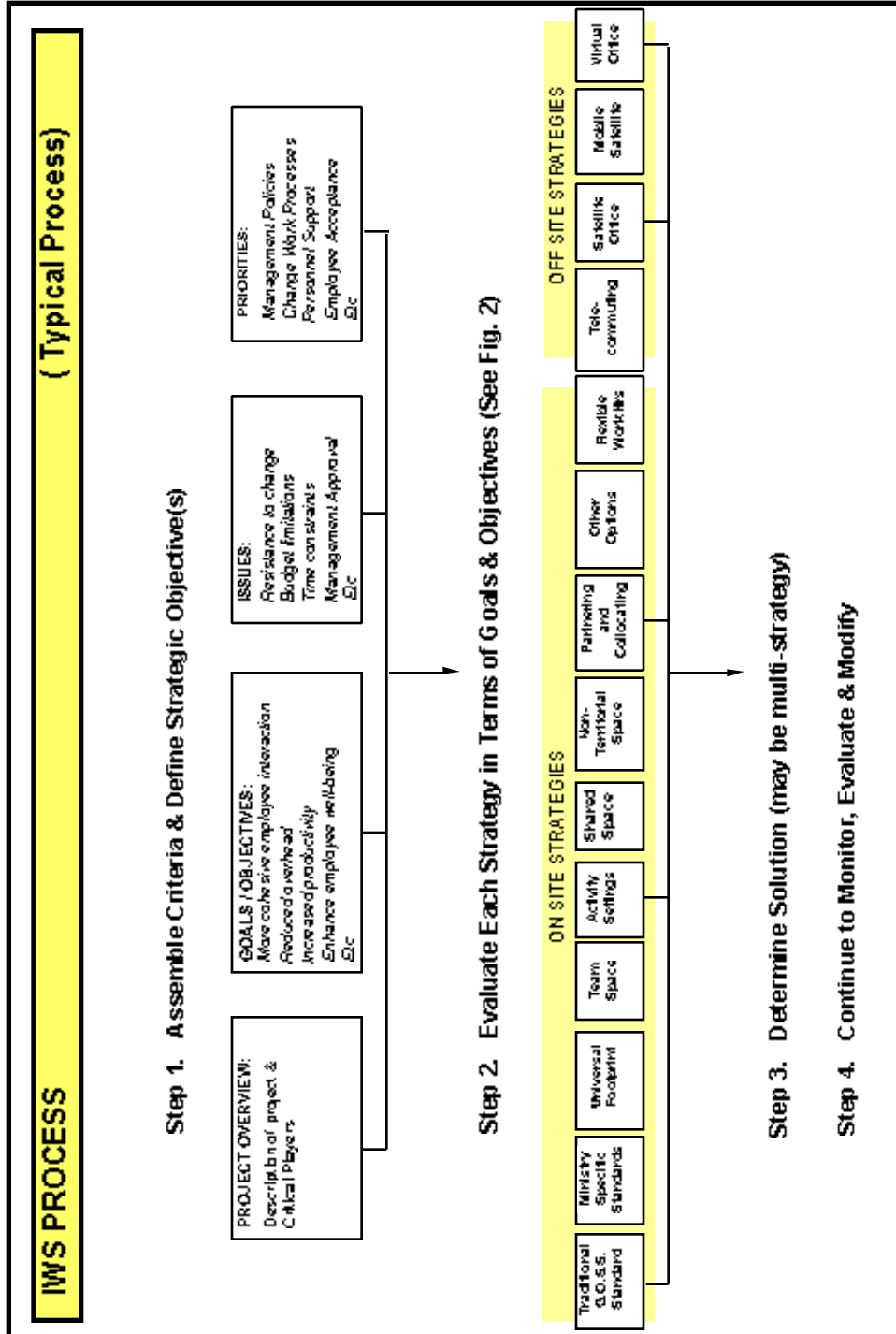

Figure 2: Planning Options Matrix

The following chart is provided as a guide for selecting IWS options that are appropriate to the desired goal or objective. Options marked with “Y” are inherently enhancing to the desired goal noted; options marked with “U” are inherently unlikely to enhance the desired goal noted; options marked with “M” may or may not enhance the desired goal depending upon the application.

Legend:

- Y - Recommended to enhance objective
- M - May enhance objective, however it is dependant on other factors
- U - Unlikely to enhance objectives
- na - Not Applicable

Strategies												
	On-Site								Off-Site			
Ministry Specific Stds.	Simplified Standards	Universal Footprints	Team Space	Activity Settings	Shared Space	Non-Territorial Space	Partnering	Variable Work Hours	Tele-commuting	Satellite Office	Virtual Office	Mobile Equipped

Goals & Objectives

Reducing Costs & Expediency

Reduce cost of accommodation	M	M	Y	M	M	Y	Y	Y	M	M	M	M	M
Reduce cost of tenant improvements	M	M	Y	M	M	Y	Y	Y	M	M	U	M	M
Reduced cost of accommodating churn	M	Y	Y	Y	Y	Y	Y	Y	M	M	U	M	M
Expedience in accommodating change	M	Y	Y	Y	Y	M	Y	U	M	U	U	Y	M
Decreased disruption to accommodate change	M	Y	Y	Y	Y	Y	Y	U	Y	Y	U	Y	Y
Maximize space utilization	M	Y	Y	Y	Y	Y	Y	Y	M	M	U	M	M
Accommodate varying staff complement (GROWTH)	M	U	M	Y	Y	Y	Y	M	Y	M	U	Y	M
Accommodate organizational change	U	Y	Y	Y	Y	M	Y	U	M	M	U	M	M
Increased utilization of facilities or equipment	U	U	Y	Y	Y	Y	Y	Y	Y	M	U	M	M
Reduced furnishings & equipment costs	U	M	Y	Y	M	Y	Y	M	M	U	U	M	M
Expedient to implement (Initially)	U	U	U	U	U	U	U	U	U	M	U	U	U

Productivity, Creativity & Wellbeing

Enhance employee productivity	M	M	M	Y	Y	M	U	na	Y	Y	Y	Y	Y
Reduce non-productive time.	U	U	Y	Y	Y	na	U	na	Y	Y	Y	Y	Y
Support innovation and creativity	U	U	U	Y	Y	U	M	M	U	U	U	U	U
Increase employee interaction & communication	U	U	U	Y	Y	U	Y	M	U	U	U	Y	Y
Enhance employee empowerment	M	M	M	Y	Y	U	U	U	M	Y	Y	Y	Y
Enhanced service delivery	M	U	U	Y	Y	U	M	Y	Y	Y	Y	Y	Y
More functional space utilization	Y	Y	M	Y	Y	U	Y	U	Y	M	U	M	M
Enhanced employee acceptance /ownership	Y	Y	Y	M	M	U	U	U	Y	Y	Y	Y	Y
Technical & administrative support critical	U	U	U	U	U	U	Y	U	Y	U	Y	U	M
Personally non-threatening	Y	M	M	M	U	M	U	Y	M	Y	Y	M	U
Limited application (Job functions)	U	U	U	U	U	U	Y	U	U	Y	U	Y	Y
More effective support space	M	Y	Y	Y	Y	M	Y	Y	U	M	U	M	M
Disruptive to individuals involved	U	U	U	M	M	M	Y	U	U	U	U	M	U

Strategies

	On-Site								Off-Site			
Ministry Specific Stds.												
Simplified Standards												
Universal Footprints												
Team Space												
Activity Settings												
Shared Space												
Non-Territorial Space												
Partnering												
Variable Work Hours												
Tele- commuting												
Satellite Office												
Virtual Office												
Mobile Equipped												

Legend:

- Y - Recommended to enhance objective
- M - May enhance objective, however it is dependant on other factors
- U - Unlikely to enhance objectives
- na - Not Applicable

Goals & Objectives

Employee & Environmental

Promotes equity and equality	M	M	Y	Y	Y	M	Y	na	M	na	na	na	na
Environmentally beneficial (pollution/traffic)	U	U	U	U	U	U	U	U	Y	Y	Y	Y	Y
Personal benefits to employee	Y	M	U	Y	Y	M	U	U	Y	Y	Y	Y	Y
Enhanced recognition of individuality	M	U	U	M	M	U	U	U	Y	Y	M	Y	Y
Security issues are significant	U	U	U	M	M	M	M	M	U	M	M	M	M

3.3 On Site Options

GOSS	Workspaces are now based on functional requirements, with defined maximum workspace sizes by job title (<i>Refer to Section 5</i>). Individual work activities should be assessed to determine the appropriate footprint size.
<i>Ministry Specific Standard</i>	The standards that a client Ministry wishes to use for its accommodation requirements are developed separately, beyond the Space Standards detailed in this manual. (<i>Refer to Appendix B.</i>)
<i>Simplified Standards</i>	An approach to space planning and space allocation that simplifies and adjusts the GOSS standards, to suit a specific client objective, within the overall GOSS envelope.
<i>Universal Footprint</i>	This is a versatile method of space planning in which a minimum number of standard footprint sizes and shapes are used. Typical applications use two or three standard sizes within modules of one another. Footprint sizes are determined by function and adapted to the building site in a generic manner. This method of planning supports “Briefcase moves” (moving people, not walls or furniture).
<i>Team Space</i>	Flexible work areas are required to support project teams as they expand or shrink. Today there are more teams performing a variety of tasks. The layout should reflect the differences. (<i>Refer to team space example plan following Section 3.4</i>)
<i>Activity Settings</i>	Refers to a variety of work settings that accommodate diverse tasks or group activities rather than planning for dedicated workstations. Users move from space to space according to task requirement (e.g. common layout / project space).
<i>Shared Assigned</i>	Two or more employees share a single, assigned workspace including work tools, either simultaneously or on different shifts or schedules.
<i>Non-Territorial</i>	A strategy where workspace is not dedicated to any one individual.
Hotelling:	A system where non-territorial workspace is booked ahead for a specified block of time. Administrative systems and supports are required to schedule and equip the space for the various users.
Motelling:	Similar to “Hotelling” however the workspace is booked upon arrival, not reserved ahead.
Free Address/ Hot Desking:	Workspaces are not reserved and operate on a first-come, first-served basis. They are available to anyone within the organization.
<i>Partnering</i>	Different organizations work out a relationship that is mutually beneficial to both parties. Not necessarily related to space, e.g. Canadian Tire sells fishing licenses for the Ministry of Environment.
<i>Co-location</i>	Different organizations agree to share space or other resources for mutual benefit such as reduced overhead and equipment requirements.

Variable Work Hours Workers choose variable work hours reducing demand on the number of on-site workspaces. More individuals can make use of fewer spaces. This can be achieved with both part-time and full-time staff having flexible schedules.

3.4 Off Site Options

Telecommuting A term used to describe work performed by employees from remote locations, usually their homes. The telecommuter replaces the daily “commute” to a central office with an electronic connection. Typically, 2-3 days a week are spent working at home and the remaining time at the central office. The central office space could be shared (e.g. hotelling).

Satellite Officing Office centres providing technology and administrative support from a location closer to employee’s home or customers. They are staffed by employees dedicated both to that site or split between that location and another.

Mobile Officing Mobile workers spend a large amount of time outside the central office, working from a variety of locations throughout a typical week. Some are provided with specially equipped vehicles. This enables them to perform their work in the field while maintaining contact with central office and other parties.

Virtual Office Through the use of portable technology, employees are able to work anywhere (i.e. home, car, ferry, hotel, client’s office, etc).

Sample Comparison

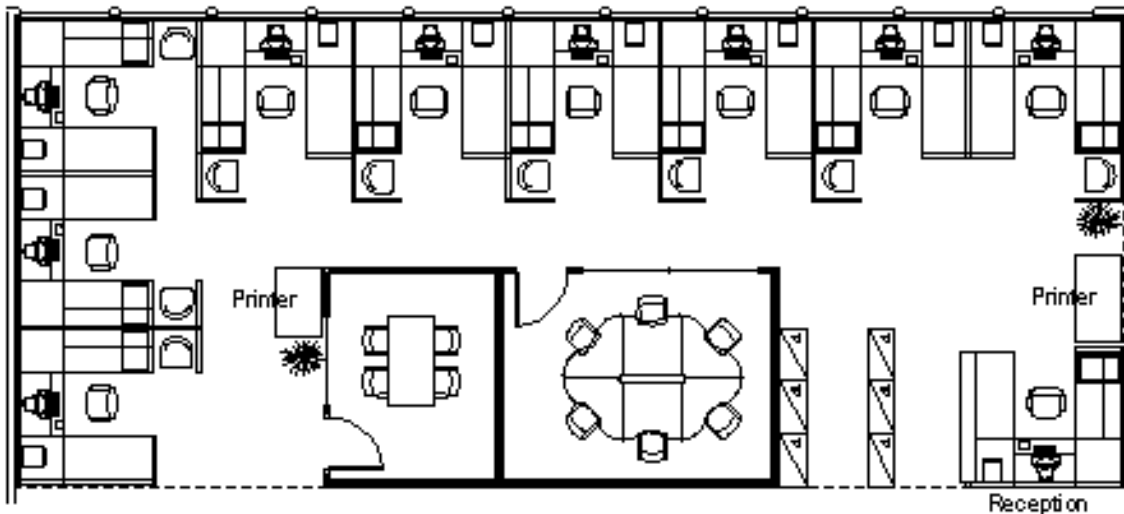

TRADITIONAL OPEN PLANNING
156M² (1675 sq. ft.)

- 10 Dedicated Workstations
- Large Meeting Room
- Small Meeting Room
- 1 File Area
- 2 Printers

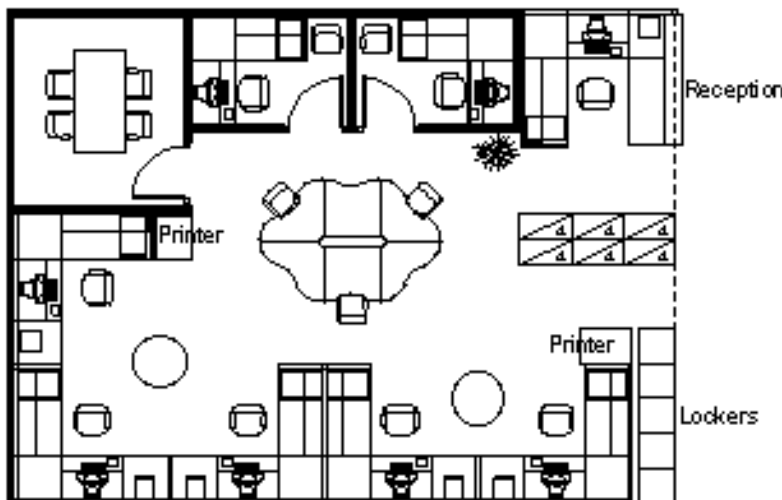

TEAM WORKSPACE PLANNING
100m² (1076 sq. ft.)

- fosters team interaction
- provides shared private stations
- 35% space reduction

- 1 Dedicated Station
- 5 Non-territorial Stations
- 2 Privacy Workstations
- 1 Large Team Meeting Area
- 1 Small Meeting/Work Area
- 1 File Area
- 2 Printers
- 10 Storage Lockers

----- end of section 3 -----

4.1 Introduction

The purpose of this section is to outline the process for documenting how functional space requirements are gathered and the approval process.

4.2 Process Flow

4.2.1 Project Identification

A project is identified when the Field Staff, Ministry Head Office, or BCBC indicates that a space change is required. Once identified, the ministry Facilities Manager will begin to develop an Accommodation Requirements Outline (ARO) or direct field personnel to do so. The functional space requirements are a key component of this document.

4.2.2 Data Assembly & Approvals

The functional space requirements data is to be gathered and assembled in an electronic spreadsheet (MS Excel Workbook®) called "**Functional Space Requirements**".

A sample "workbook" page is illustrated in Figure 3; detailed instructions for recording data can be found in Section 4.3; and the instruction "notes" in the "workbook" page are illustrated in Figure 4.

The preliminary functional space requirements "workbook" should then be forwarded electronically to the Customer and Portfolio Services Group of BCBC. Working with the Ministry Facilities staff, BCBC will review the requirements and identify space and cost savings opportunities. All space requests are subject to Treasury Board audit. Once the workbook has been transferred to BCBC, they will be responsible for data management and changes.

4.3 Functional Space Requirements – Workbook Instructions

4.3.1 Purpose

These instructions are directed to the person who is charged with collecting the Functional and Program requirements for their group. If at any time the user is not sure, they should be directed to contact their facilities representative.

The data is to be assembled in a preformatted electronic spreadsheet (MS Excel® workbook), which is available from the facilities representative. The data may be assembled into one large worksheet, or broken into individual worksheets within the workbook. ***It is generally best to do a separate worksheet for each department or business unit.***

4.3.2 Navigating the Form

The form is colour coded.

- Black Text represents areas that should be overwritten, if required.
- Blue text represents data which is formula based, and may be overwritten due to program requirements.
- Red text represents data which is formula based, and should not be overwritten.

Only the people spaces, and support spaces section of the form require manual input. The Circulation spaces are automatically calculated.

4.3.3 People Spaces

People Spaces are those spaces that are occupied by individual members of the group. The area allocations are determined by function.

This area requires the following information: the number of persons with their function or job title (i.e. File Clerk); and their name (i.e. Smith, L) which is optional.

The description of the space types and detail space types (sorted by job title) can be found in Section 5. Once these parts of the form are filled in, the workbook will automatically determine the amount of space required for the people.

4.3.4 Support Spaces

Support spaces are those spaces that support the people identified in the People Spaces and are not part of their workstation. ***Refer to Section 6.1- Support Space Five Stage Analysis for more detailed direction.***

Space allowances for equipment such as filing cabinets, copiers, printers, etc. are shown in Section 6.1- Table 1. For those items not listed, measure the item and allow for additional space to access the item. The drawing below Table 1 indicates how the space is determined for a typical lateral file cabinet.

The total area allocation for break areas (Section 6.1- Table 2) and meeting rooms / training rooms (Section 6.1- Table 3) is based on the number of staff.

5.1 Space Allocation – Functional Space Requirements for Individual Workspaces

Functional analysis of work indicates that various job functions can be successfully accommodated within the maximum space allocations outlined in the figure below. Refer to Section 5.2 for layout options with traditional or systems furniture.

Refer to Section 5.8- Functional Space Requirements Matrix for maximum workspace allocation by specific job classification.

Personal requirements specific to a workstation should be located within the workspace. Additional support requirements, which functionally need to be located near the workstation, should be listed under Support Space Allocations.

Figure 5: Footprint Sizes and Criteria

The base allocation for all classifications is 6.50 m² except where the functional requirements require only an area of 4.50 m². The functional criteria is outlined below.

Ministry facility representatives will review and approve the functional justifications. Deviations beyond the functional justification and the private offices (as noted in the matrix) must be approved by the Deputy Minister or designate.

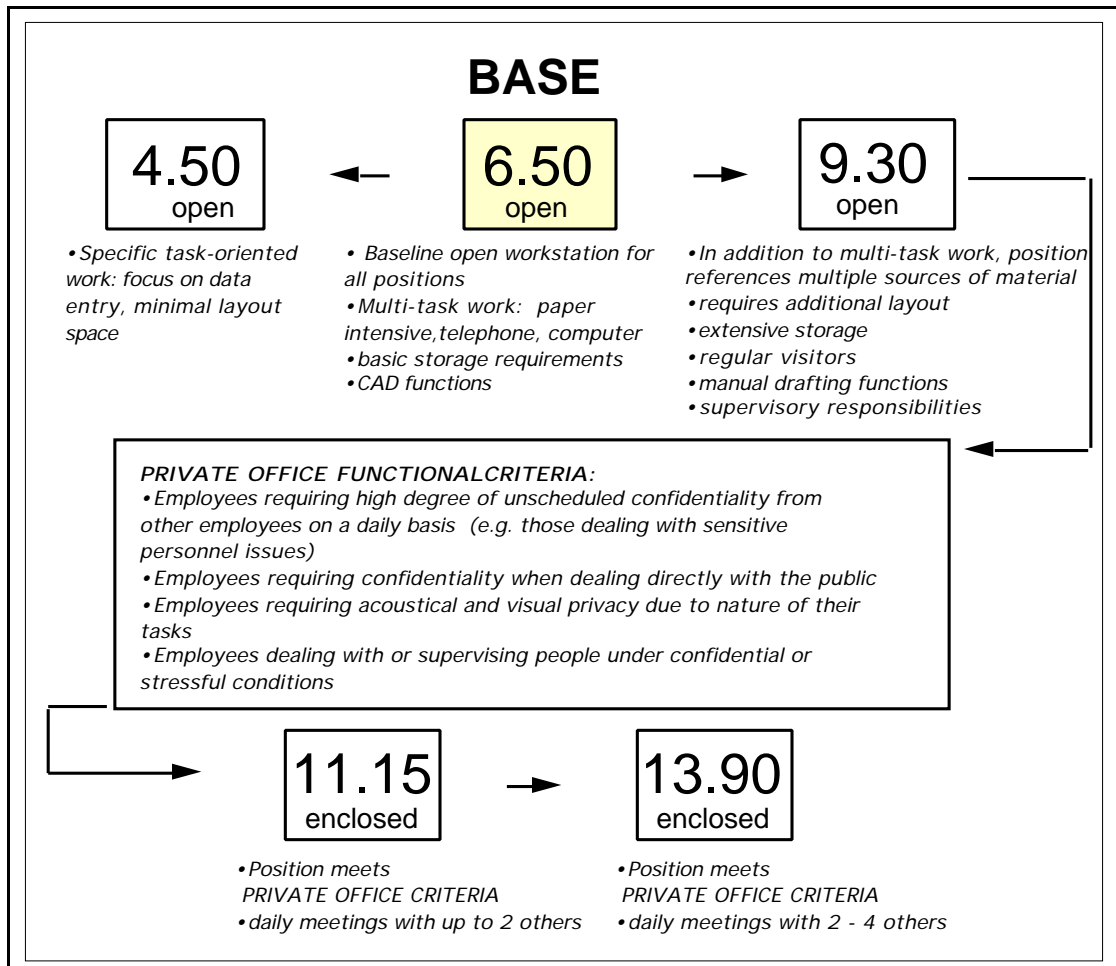

5.2 Space Type A – Open Workstation 4.5m² 50ft²

Dimensions are measured centre to centre

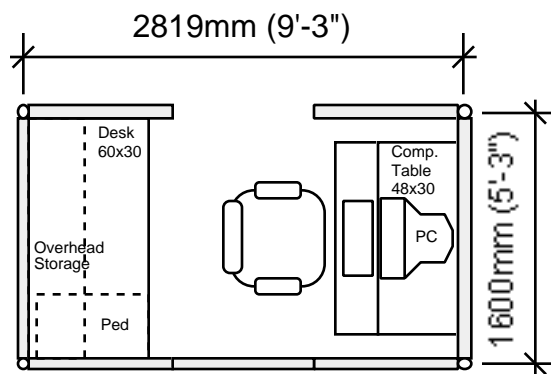
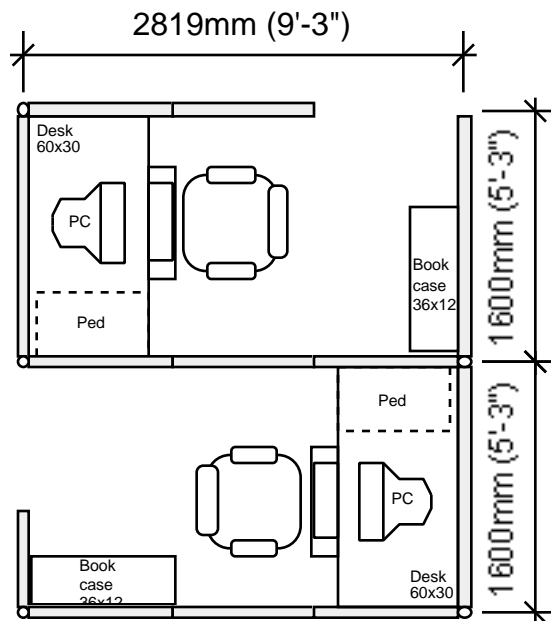

* Note: furniture and screens shown are not necessarily an entitlement

5.3 Space Type B – Open Area 6.5m² 70ft²

Dimensions are measured centre to centre

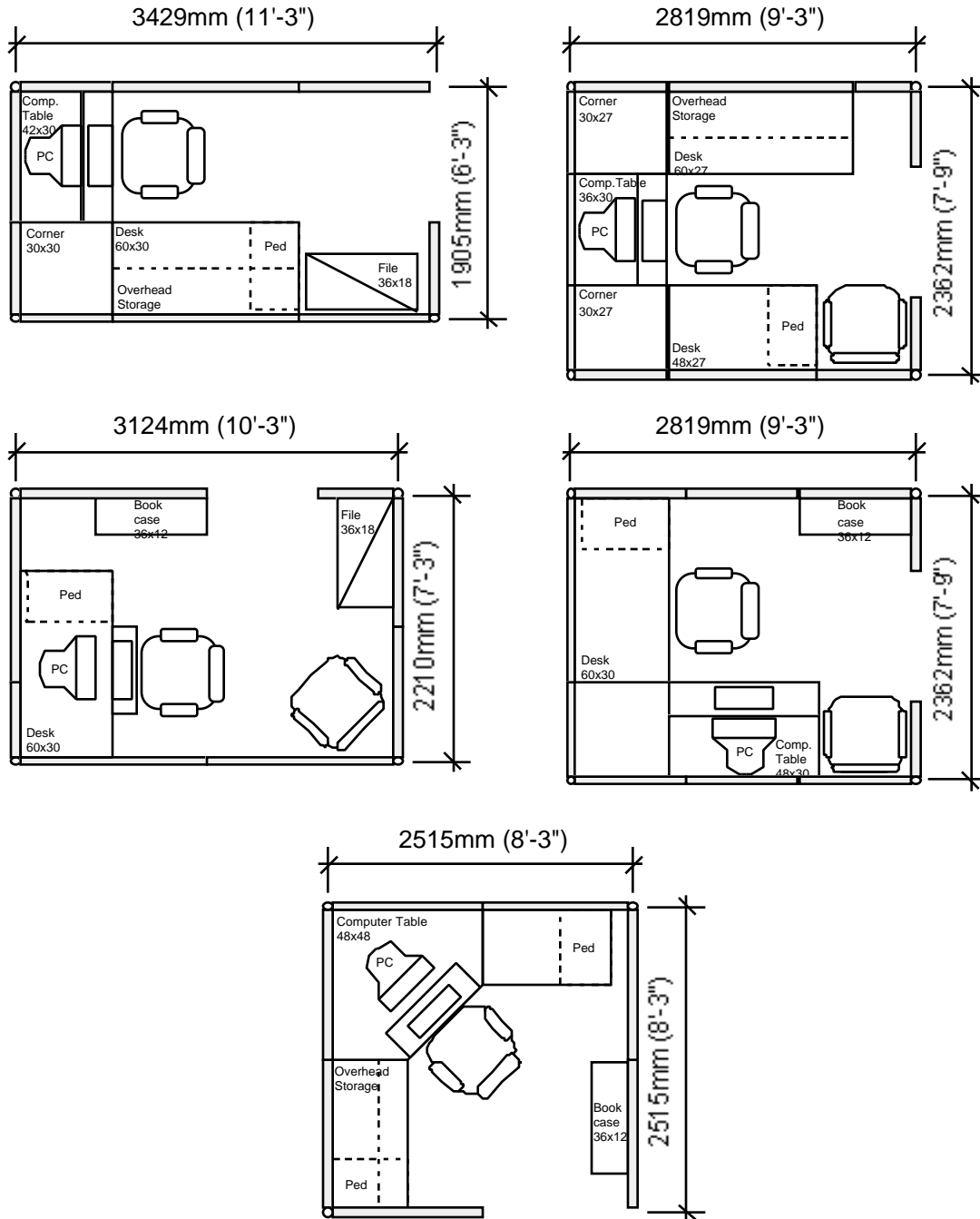

* Note: furniture and screens shown are not necessarily an entitlement

5.4 Space Type C – Open 9.3m² 100ft²

Dimensions are measured centre to centre

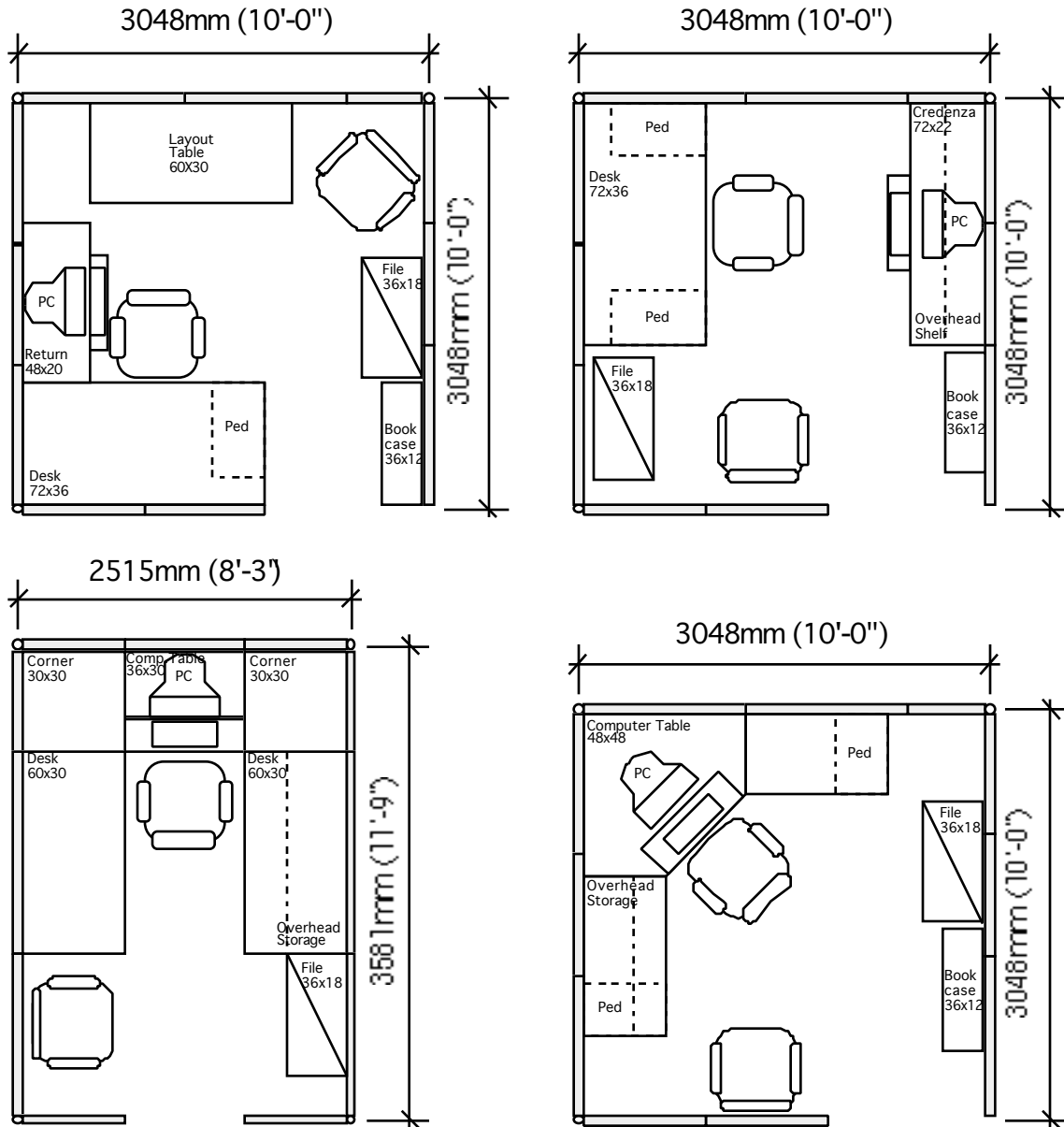

* Note: furniture and screens shown are not necessarily an entitlement

5.5 Space Type D – Enclosed Area 11.15m² 120ft²

Dimensions are measured centre to centre

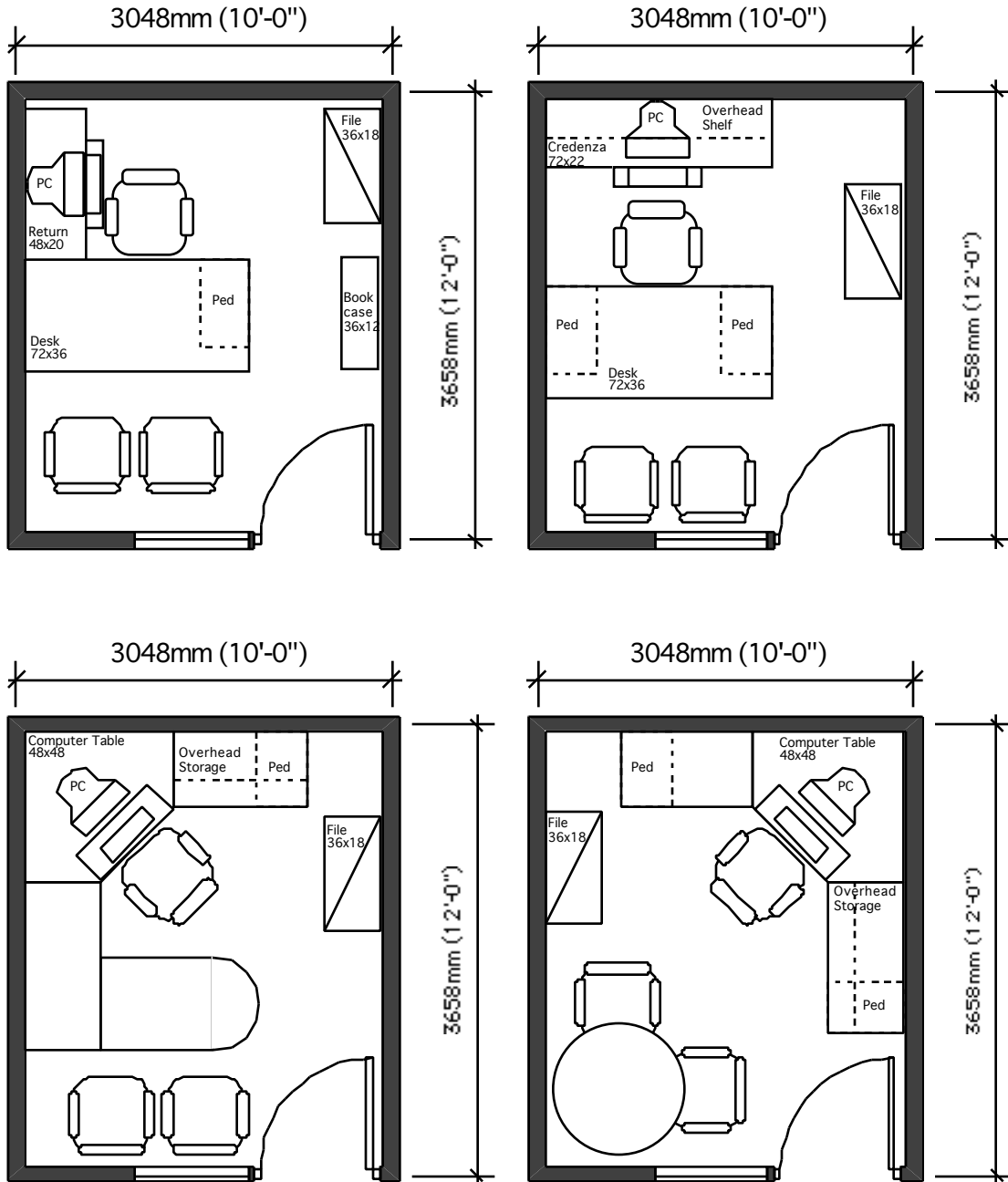

* Note: furniture shown is not necessarily an entitlement

5.6 Space Type E – Enclosed Area 13.9m² 150ft²

Dimensions are measured centre to centre

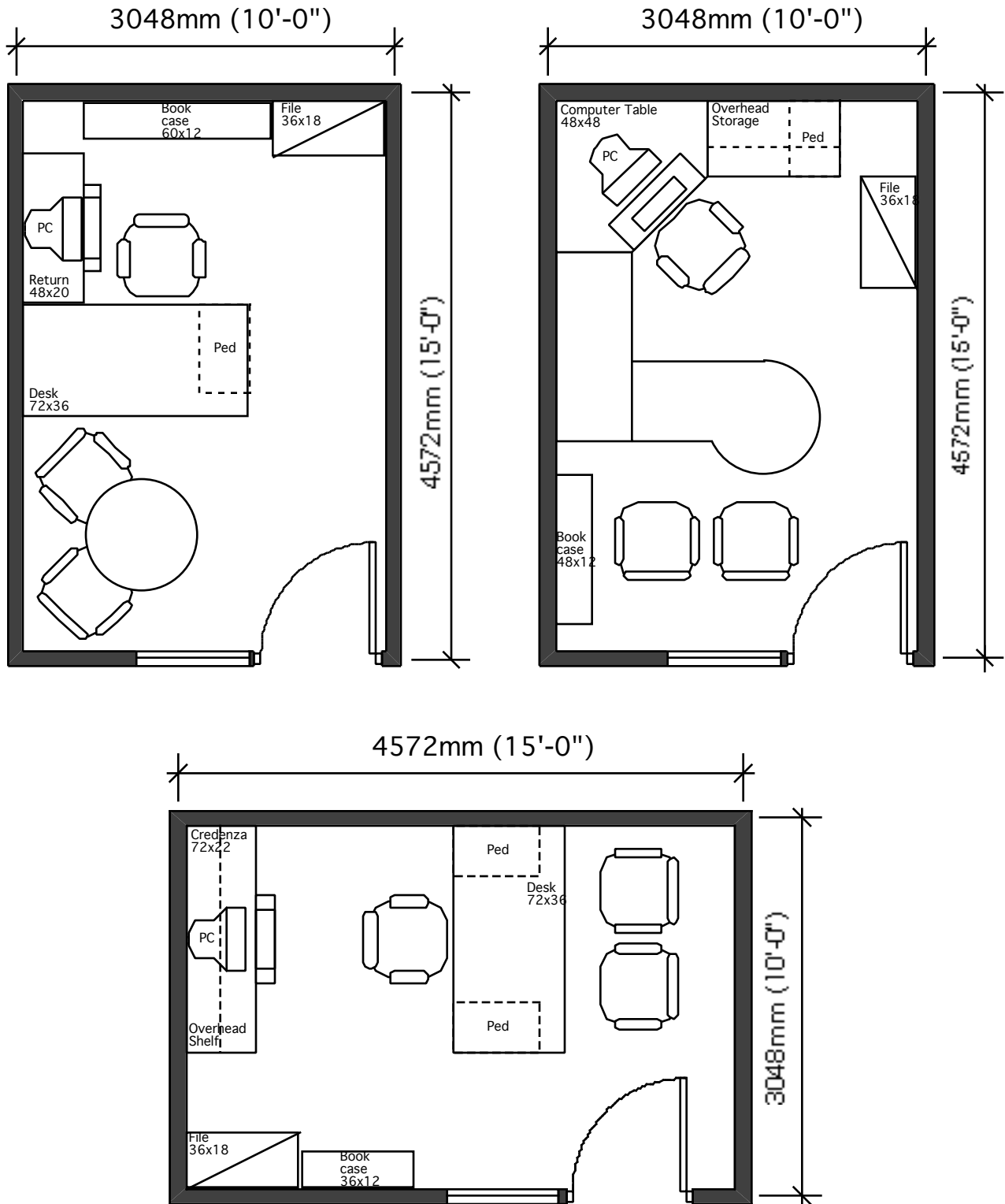

* Note: furniture shown is not necessarily an entitlement

5.7 Space Type F – Enclosed Area 22.5m² 240ft²

Dimensions are measured centre to centre

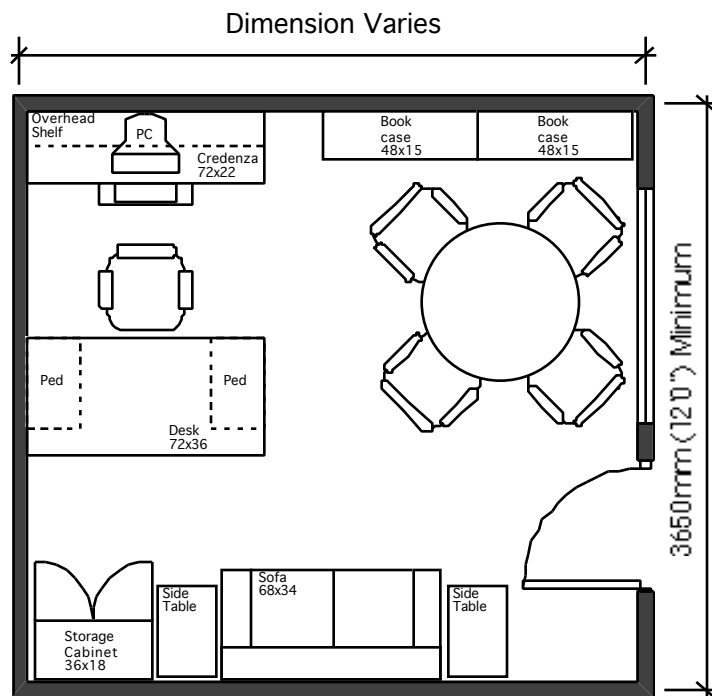
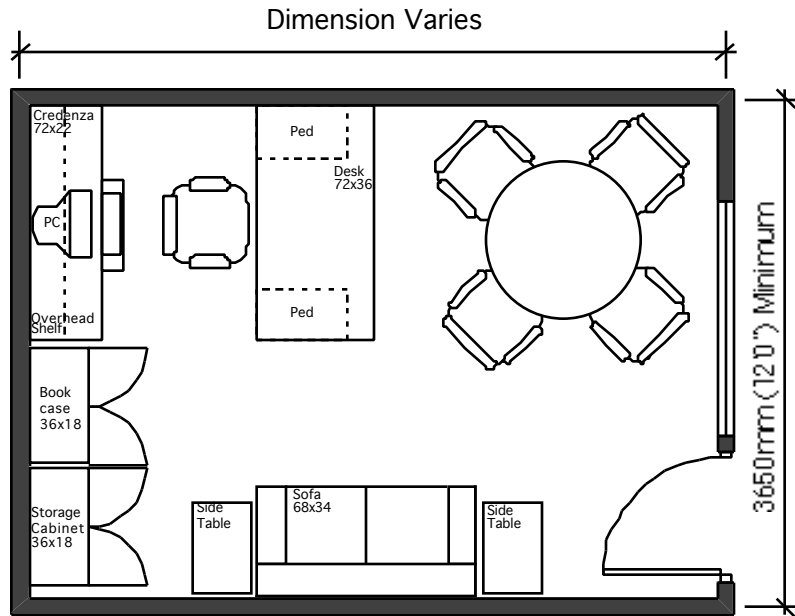

* Note: furniture shown is not necessarily an entitlement

5.8 Functional Space Requirements Matrix

Complete Job Classification	Open Area			Enclosed Area			
	A 4.50 m ² 50 ft ²	B 6.50 m ² 70 ft ²	C 9.30 m ² 100 ft ²	D 11.15 m ² 120 ft ²	E 13.90 m ² 150 ft ²	F 22.50 m ² 240 ft ²	G 28.0 m ² 300 ft ²
Accounting Officer			●				
Administrative Officer		●					
Administrative Officer (with Functional Justification)			●				
Archivist		●					
Archivist (with Functional Justification)			●				
Assistant Deputy Minister						●	
Biologist			●				
Building Security Officer	●						
Clerk		●					
Clerk (with Functional Justification)			●				
Clerk Postal	●						
Clerk Stenographer		●					
Clerk Stenographer (with Functional Justification)			●				
Communications Officer		●					
Communications Officer (with Functional Justification)			●				
Community Nurse		●					
Coop Position	●						
Coop Position (with Functional Justification)		●					
Coop Position (with Functional Justification)			●				
Coop Education Trainer Program	●						
Counselor, Apprentice/Industrial Training			●				
Deputy Minister							●
Director (or Equivalent)					●		
Economist			●				
Education Officer		●					
Executive Coordinator			●				
Executive Secretary		●					
Executive Secretary (with Functional Justification)			●				
Financial Officer		●					
Financial Officer (with Functional Justification)			●				
Government Agent				●			
Government Agent (with Functional Justification)					●		
Heritage Resource Officer		●					

Complete Job Classification	Open Area			Enclosed Area			
	A 4.50 m ² 50 ft ²	B 6.50 m ² 70 ft ²	C 9.30 m ² 100 ft ²	D 11.15 m ² 120 ft ²	E 13.90 m ² 150 ft ²	F 22.50 m ² 240 ft ²	G 28.0 m ² 300 ft ²
Heritage Resource Officer (with Functional Justification)			●				
Information Systems Analyst		●					
Information Systems Analyst (with Functional Justification)			●				
Inspector Boiler		●					
Inspector Elevator		●					
Inspector Electrical		●					
Inspector Fire Commissioner's Office		●					
Inspector Fire Commissioner's Office (with Functional Justification)			●				
Inspector Gas		●					
Labour/Health Services Officer		●					
Labour/Health Services Officer (with Functional Justification)			●				
Legal Counsel					●		
Librarian		●					
Librarian (with Functional Justification)			●				
Licensed Psychologist			●				
Licensed Psychologist (with Deputy Approval)				●			
Licensed Science Officer			●				
Medical Coder		●					
Medical Officer					●		
Medical Records Librarian		●					
Medical Records Technician		●					
Manager			●				
Manager (with Deputy Approval)				●			
Nurse		●					
Nutritionist		●					
Occupational Therapist		●					
Office Assistant		●					
Operator, Data Processing	●						
Operator, Key Punch	●						
Park Assistant		●					
Pharmacist		●					
Pharmacist (with Functional Justification)			●				
Photo Art Technician		●					
Planning Officer			●				
Provincial Fire Control Officer				●			
Public Service Training Program	●						

Complete Job Classification	Open Area			Enclosed Area			
	A 4.50 m ² 50 ft ²	B 6.50 m ² 70 ft ²	C 9.30 m ² 100 ft ²	D 11.15 m ² 120 ft ²	E 13.90 m ² 150 ft ²	F 22.50 m ² 240 ft ²	G 28.0 m ² 300 ft ²
Rehabilitation Consultant			●				
Research Officer		●					
Research Officer (with Functional Justification)			●				
Safety Officer			●				
Science/Technical Officer		●					
Science/Technical Officer (with Functional Justification)			●				
Shipper	●						
Social Program Officer			●				
Social Program Officer (with Deputy Approval)				●			
Stockworker	●						
Systems Analyst		●					
Systems Analyst (with Functional Justification)			●				
Technical Enforcement Officer		●					
Technical Enforcement Officer (with Functional Justification)			●				
Training Consultant			●				
Youth Employment Program	●						

----- end of section 5 -----

Support space is allocated for the provision of such functional areas as: Filing, Printers, Mail area, Copiers, Break Areas, Meeting Rooms, Reception Areas, Main Building Reception, Security Room, Mailroom, etc. Such allocations are expressed in unit areas of space. Allocations may be Open Areas (OA), Semi-Enclosed (SE) or Enclosed Areas (EA).

6.1 Support Space Five Stage Analysis

The support space requirements can be separated into the following five parts:

- .1 *Dedicated Support Space*: A space allowance for files, equipment, storage, etc., that is shared with others and must be located outside but adjacent to the individual's workspace.

May include such items as files, equipment, or storage that are required to perform the specific tasks of the position and that must be functionally located with the position and is in addition to the standard workstation. Individual workstation support shall not be considered as a means of accommodating excess furniture etc.

(Refer to Table 1- Furniture and Equipment to determine the space allocation required.)

- .2 *Group Support Space*: A space allowance for files, equipment, storage, enclosed rooms, meeting areas etc. which is shared by a group of workers.

May include such items as equipment, storage or interaction areas required to perform the specific tasks of the group that must be functionally located within the group area.

In the interests of maximizing space utilization, areas that may be shared with other functional groups shall be allocated as "on floor or off floor" common support space rather than dedicated group support space. (Security or function may dictate otherwise).

(Refer to Table 1- Furniture and Equipment to determine the space allocation required.)

- .3 *Floor Common Support Space*: A space allowance for support facilities that are shared by all groups on the floor. May include such items as meeting rooms, break areas, reception areas, etc. These spaces should ideally be located convenient to the entire floor to minimize having to travel through other working groups' areas.

- .4 *Building Common Support Space*: May include such items as: Main Building Reception, Security Room, Mailroom, large meeting facilities, training rooms and recycling rooms etc. May be located on any floor within a building, not necessarily the main floor or basement.

- .5 *Remote Support Space*: Support space located off-site or at a remote location. May include records storage, meeting rooms, training facilities etc. Refer to Table 1- Furniture and Equipment to determine the space allocation allowable and/or required.

Table 1 provides a number of allocations and unit measurements that are intended to assist in calculating Dedicated, Group and Floor Common Support Space Allocations.

The access space required to utilize furnishings and equipment is included in the space allowance calculations for the item.

Table 1: Furniture and Equipment¹

Furniture		Allocation
Filing cabinets (not in People Space)		1.0 m ² each
Visitor's chairs		1.0 m ² each
Bookcases	up to 1.0 m wide over 1.0 m wide	1.0 m ² each 0.9 m ² per m width
Credenza		1.1 m ² per m width
Tables and other working surfaces	0.61 m deep 0.76 m deep 0.91 m deep	1.2 m ² per m width 1.4 m ² per m width 1.5 m ² per m width
Meeting tables		net area of top (if circular, measure square overall) add chairs as above
Drafting tables		2.0 m ² per m width
Layout tables	60" x 30" 72" x 36"	2.6m ² 3.3m ²
VDT. tables (including chair)		1.8 m ² per m width
Cupboards - measure with doors fully opened		net floor area
Equipment		Allocation
Major copy centre		As programmed
Copier - Standard on Floor		2.5 m ²
Printer - Standard Laser Jet Printer on Floor		1.7 m ²
Fax - Standard on Floor		1.0 m ²
Special items		Measure width x (depth + 0.6 m). Add 0.6m to any other face requiring access.

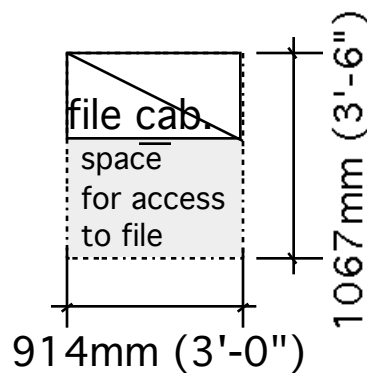

Note: Total space required is 1.0m²

¹ This table is to be used to determine space allocated for items not found in the people space.

Table 2: Break Areas

	m²	ft²
10 staff or less	4.6	50
11 to 20 staff	11.15	120
21 to 30 staff	13.9	150
31 to 40 staff	16.7	180
41 to 50 staff	18.0	194
For every 10 staff over 50 add 1.3 m ² i.e. 100 staff = 18 + (5x1.3) = 24.5 m ²	1.3	14

Table 3: Meeting & Training Room Total Allocation

	m²	ft²
10 staff or less with functional justification	16.7	180.0
Add 1.0 m ² for each additional staff over 10	1.0	10.76
i.e. 100 staff = 16.7 + (90x1.0) = 106.7 m ²	106.7	1148.5
<p><i>Note:</i> The above allocation is based on general office space with normal training facilities. Special requirements that exceed general office requirements, i.e. hearing rooms, project rooms, etc. would be in addition to the above and are programmed specific to the client's requirements. Training Centres may vary from the above allocation depending upon functional requirements.</p>		

Table 3a: Meeting Room Size Guidelines

	m²	ft²
Very small meeting room (3 - 5 people)	11.15	120.0
Small meeting room (6 - 8 persons)	13.9	150.0
Standard meeting room (8 - 10 persons)	16.7	180.0
Medium meeting room (10 - 12 persons)	22.30	240.0
Large meeting room (16 - 18 persons)	29.70	320.0
Very large meeting room (20 - 24 persons)	44.60	480.0
Meeting rooms in excess of 24 persons	1.86 m ² / person	20 ft ² / person

Figure 6: Meeting Area 11.15 m²

Dimensions are measured centre to centre

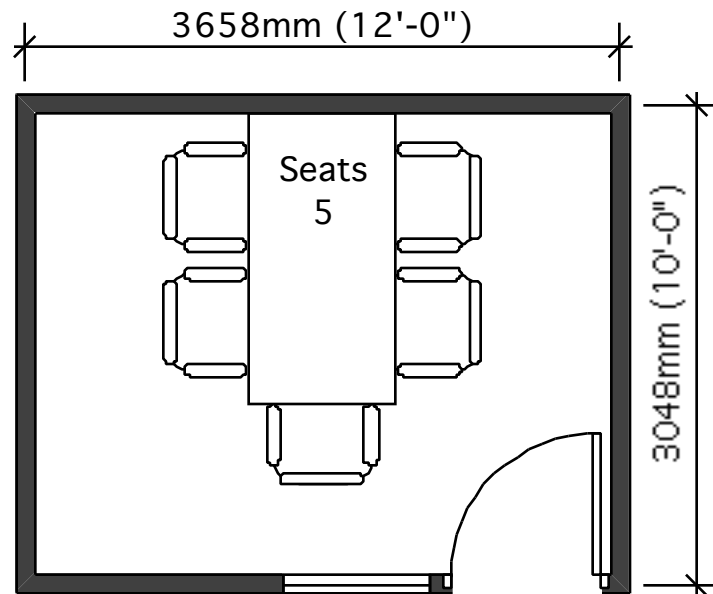

Figure 7: Meeting Area 13.90 m²

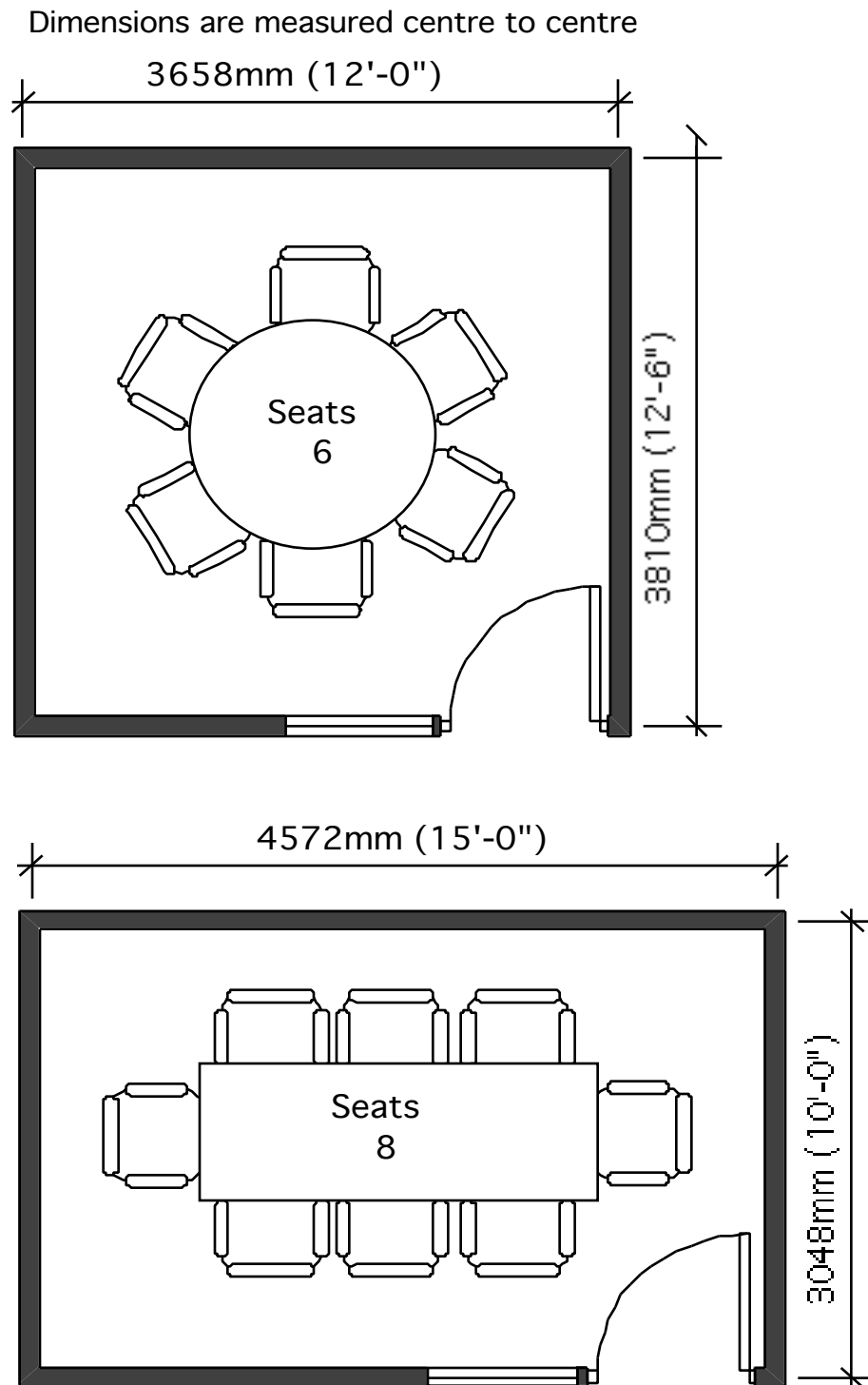

Figure 8: Meeting Area 16.70 m²

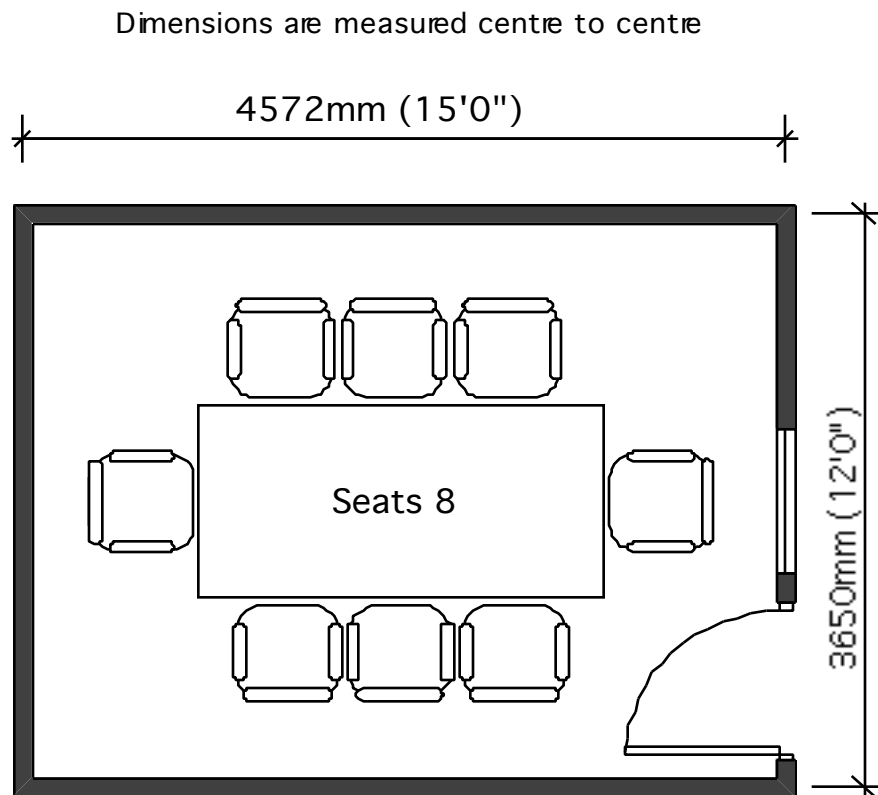

Figure 9: Meeting Area 22.30 m²

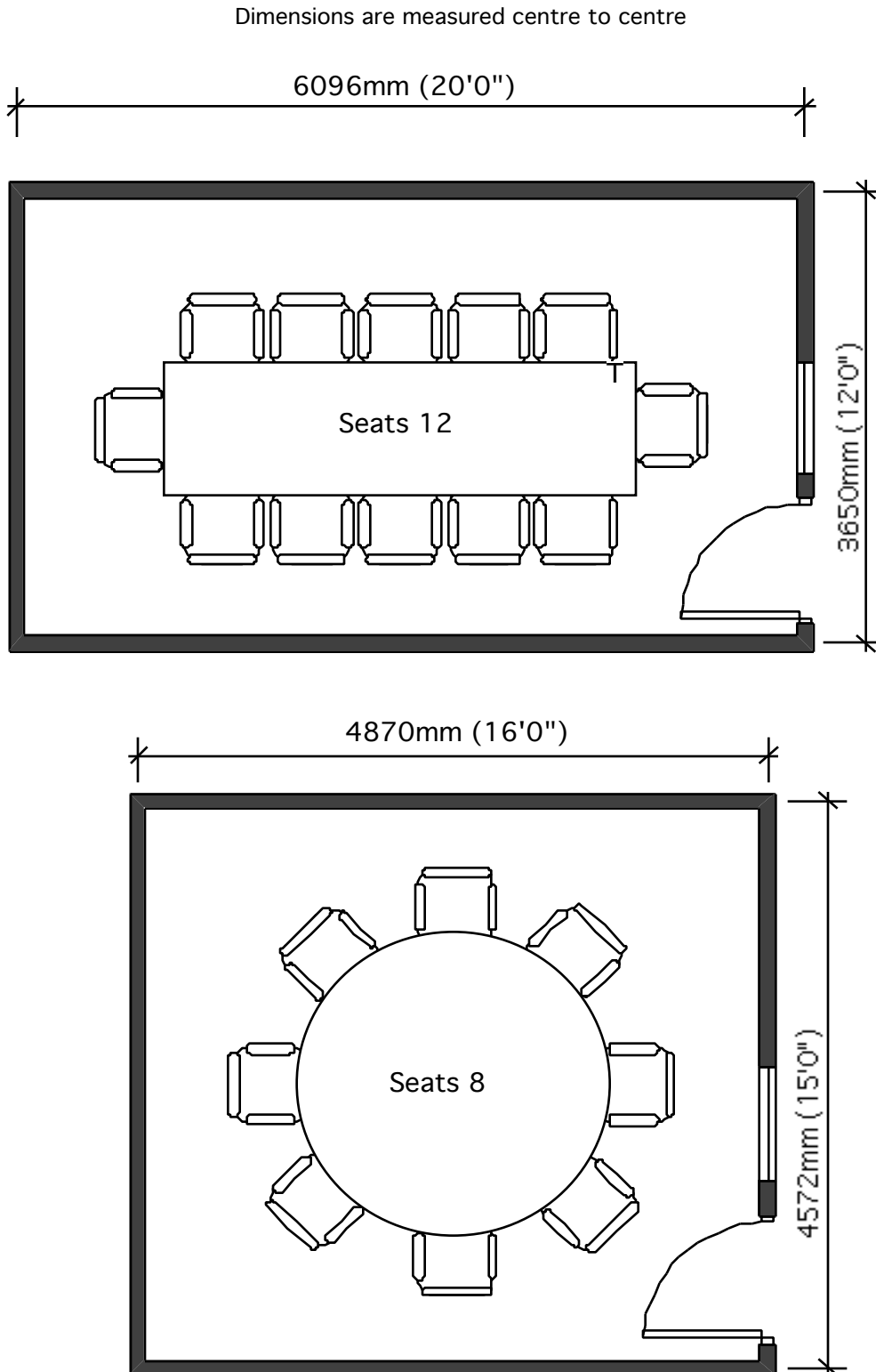

Table 4: Data & Telecommunications

Data Equipment Room	
<p>Contains the servers and network equipment as required by the tenant. Area to be functionally programmed to meet client's needs.</p> <p><i>Defined by the client with assistance from BCBC as required.</i></p>	<p>Part of the programmed area, to be defined in the functional space requirements.</p>
Demarcation Room	
<p>This room is where the service provider installs and terminates the telephone service entrance cable. If all the tenants in the building are government, this could be part of the voice equipment room.</p> <p><i>Defined in BCBC Technical Standards</i></p>	<p>Part of the mark up to rentable area.</p>
Voice Equipment Room(s)	
<p>Contains the PABX and any associated equipment to provide the voice service. (Not required for Centrex)</p> <p><i>Defined in BCBC Technical Standards</i></p>	<p>Part of the mark up to rentable area.</p>
Telecommunication Closet(s)	
<p>All horizontal and riser data/voice cabling for a given floor terminates in this closet. It includes the patch panels and network hubs for that floor.</p> <p><i>Defined in BCBC Technical Standards</i></p>	<p>Part of the mark up to rentable area.</p>
MAN Room (Only applicable in downtown Victoria)	
<p>The MAN room is an optional requirement of ITSD for termination of the Metropolitan Area Network cable. <i>The requirement for a MAN room is at the direction of the ITSD Voice Application Manager (Gordon Higgins) at (250) 387-7932.</i></p> <p>The lease costs and tenant improvement costs are at the expense of ITSD.</p>	<p>When required it is part of the programmed area to be defined in the functional space requirements.</p> <p>Area required: 10m² enclosed</p>
RNC Room (Applicable in remote areas)	
<p>The RNC (Remote Network Centre) room is an optional requirement of ITSD for termination of their cabling in a remote area. <i>The requirement for a RNC room is at the direction of the ITSD Voice Application Manager (Gordon Higgins) at (250) 387-7932.</i></p> <p>The lease costs and tenant improvement costs are at the expense of ITSD.</p> <p>Area Required: Small RNC = 10m² Large RNC = 20m²</p>	<p>When required it is part of the programmed area to be defined in the functional space requirements.</p> <p>Area required: 10m² or 20m² as determined by ITSD</p>

**Table 5: Washroom, Shower and Change Room Facilities
(Program requirement in excess of base building)**

Washrooms	m²	ft²
Minimum area for WC and sink (Room 6'x6'6")	3.7	40
<i>For additional facilities add:</i>		
WC cubicle each	2.0	22
Handicapped WC cubicle each	2.8	30
Urinal each	1.1	12
Sink each	1.1	12
Shower Stall & Change Area	1.7	18
Handicapped Shower Stall & Change Area	2.8	30

Table 6: Building Common Support Spaces

These allocations are normally included as part of the building common support space allocation and are only intended as guidelines. Their functional requirements vary considerably and the preparation of a space or facilities program is normally necessary where a whole building is likely. A "case by case" assessment and analysis of the requirements is therefore necessary for inclusion in an individual program.

First Aid Rooms		
Worker's Compensation Board's requirements. <i>Refer to Part 33- Occupational First Aid, of the Workers' Compensation Board Occupational Health & Safety Regulations.</i> Requirements vary depending upon number of occupants, hazard classification and travel time to the nearest hospital.		
Building Reception	m ²	ft ²
Unless a whole building is being considered, this is not normally provided, based on the number of visitors waiting a guide is: <i>Visitors waiting, per visitor</i> Depending on the size and class of building, additional space may be included for circulation, receptionist, etc.	0.46 - 0.90	5.0 - 10.0
Building Mailroom		
Only at request of Government Postal Branch, who will define size and layout requirements.		
Building Maintenance Workshops/Office	m ²	ft ²
Only in BCBC maintained buildings upon request of the District Office. <i>Example only, as a guide.</i>	11.15 - 20.90	120.0 - 225.0
Information Centres		
Unless a whole building is being considered, this is not normally provided. Client is to provide program requirements.		
Goods Delivery/Dispatch	m ²	ft ²
<i>Example only, as a guide.</i>	13.90	150.0
Building Recycle Room		
<i>(new buildings)</i>	11.15	120.00
On Floor Waste Storage/Recycle Area		
<i>Example only, as a guide.</i>	1.0 per 500 - 700 of office floor space	11 per 5385 - 7535 of office floor space
Telephone and Data Rooms		
<i>Refer to Table 4.</i>		
Janitor Rooms		
Determined in accordance with BCBC Technical Standards. Allocation of space is considered part of the mark up from useable to rentable area.		

6.2 Space Planning Principles

The following principles are to be followed in the design of government office space.

6.2.1 General

<i>Safety & Accessibility</i>	Space shall be planned to meet the requirement of the WCB Occupational Health and Safety Regulations, the BC Building Code, and applicable Municipal Bylaws.
<i>Efficient Space Layouts</i>	Interior layouts, circulation and space use will be efficiently planned.
<i>Flexibility</i>	Maximum flexibility for change with a minimum potential disruption to the occupants, consistent with cost-effectiveness. This may be achieved by minimizing the number of different workstation sizes and number of furniture components.
<i>Natural Light / View for Majority</i>	Natural light and views should be accessible by the majority of users in open office areas. Screen heights should not exceed 1.52m (60"). Enclosed offices should be positioned on the building core and provided with glazing to receive natural light.
<i>HVAC Alterations</i>	Enclosed areas shall be located in Heating, Ventilation and Air Conditioning (HVAC) zones that will reduce the impact on HVAC function.
<i>Precedents</i>	Planning should be done in a way that the setting of precedents affecting a large number of equivalent staff in other client Ministries does not occur.
<i>Preferred Dimensions</i>	<p>The preferred floor area is rectangular in shape with a length to width ratio of about 2:1, and with a minimum dimension of 8400mm/9150 mm (27' 6"/30' 0"). This proportion allows for the most effective layout.</p> <p>The preferred minimum dimension for private offices and enclosed spaces is 3050mm (10' 0") in width or length.</p>
<i>Systems or Modular Furniture</i>	Systems or modular furniture usually affords more efficient use of space. If existing systems furniture meets the functional requirements within a smaller footprint, then the smaller footprint will be used. The ministry has the option of reducing their space requirements accordingly or using the bonus space created for team or support space requirements.
<i>Excess Space</i>	In the event that the space acquired is larger than the functional program envelope, the extra space shall be kept whole (i.e. as a meeting area, team space etc.) rather than being dispersed so that it can be recovered.
<i>Security</i>	The design of government office space should incorporate security concerns with respect to personnel, information, and physical assets as identified in GMOP 10. An analysis of security requirements (threat/risk assessment) should be initiated at the planning stage and incorporated into the design process.

Part Time, Seasonal Staff Space shall be provided on a functional basis for temporary or seasonal staff. IWS strategies shall be encouraged to accommodate these staff.

6.2.2 Specific Rooms & Areas

File/Storage Areas File/Storage areas should be located in the open office area, using shelving and lockable filing cabinets. Where possible, centralized file storage should be considered in either open or enclosed areas. Floor loading must be considered before implementing. Semi or dead file type storage is best located off site. Note that the cost of storing each file cabinet, storage unit or bookcase on the floor equals approximately \$250-\$300 per year in rent.

Break Areas & Rooms Coffee nooks and break areas with plumbing shall be located adjacent to existing building plumbing. Coffee nooks should also be located adjacent to but outside of meeting rooms whenever possible.

Lunch Rooms Lunch rooms (as per WCB definition) are not provided. (*see Break Areas & Rooms*)

Reception Areas Reception areas, typically part of the open office area, are subject to security considerations. The area is to be defined with screens and furniture.

Libraries Technical libraries, where required, are normally part of the open office area. Control of reference material should be arranged through the users' operational procedures. Where only small quantities of reference materials requiring security are involved, lockable cabinets can be used. A lockable enclosed area may be provided where the value, nature and quantity of the materials require greater security.

Central Services Central Office Services, where required: if these involve major functions such as copying, printing, mail handling and communications that are likely to be noisy, lockable enclosed areas may be provided. The area should preferably be located adjacent the building core with adequate ventilation.

Computers Facilities Lockable enclosed areas may be provided for computer equipment where required if the equipment generates noise, poses a security problem, or requires special HVAC.

First Aid Rooms First Aid Rooms are to be provided in accordance with the WCB Occupational First Aid Regulations.

Washrooms Washrooms are to be provided in accordance with the more demanding requirements of either, the current version of the BC Building Code, or the Workplace Act, Occupational Environment Regulations.

If public and/or staff washrooms are required beyond the building standard washrooms, they must be programmed. Programmed washrooms are not considered as part of the mark-up from useable to rentable area.

----- end of section 6 -----

Mark-up factors express the difference between Programmed, Useable and Rentable areas and they are expressed as percentages.

Refer to Appendix F for diagrams.

7.1 Space Area Definitions

The definition of Useable, Rentable and Programmed areas are outlined below. They are fully defined in the BCBC's Space Measurement Standard, February 22, 1993. The standard is a modified Building Owners and Managers Association (BOMA) method of measurement.

Floor or Building Rentable Area

A measure of all internal space on a floor or floors of a building, excluding vertical penetrations. This measure is used in lease agreements. It may be calculated by measuring the actual or proposed space for rent. Alternately, it can be calculated by marking up a required useable area by a percentage factor or multiplier.

In the former case, the measurement will be in accordance with BOMA method of measurement. For a whole building the rentable area is measured to the inside of exterior walls. The factor or multiplier will vary according to the type of building and the type of tenancy, e.g., single tenant floor, multiple tenant floor, whole building, etc. Rentable area remains constant for the life of a building unless additional area is constructed.

BCBC Useable Area

A measurement that comprises the rentable area of a floor less the service rooms (washrooms, mechanical / electrical room, janitor rooms etc.) and floor common area (lobby area, corridors to exits, washrooms and service rooms).

Common area is floor area that is not under the occupants control and not available to house furniture, personnel, or space required by fire code or other restrictions; it is therefore considered non-useable.

BOMA Useable Area

Will generally include the lobby, service and life safety corridor for a single floor tenancy, (In contrast to the BCBC standard). For a multi-floor tenancy, the BOMA and BCBC standards are identical.

Both BOMA & BCBC Useable area definitions include columns, shear walls, heating convectors and window ledges. Useable area varies over the life of a building as the floor configurations vary and the floor common area is reconfigured.

Building Loss Factor

Refers to useable area that is not available for use by the occupant to house furniture or personnel due to significant building impediments and / or floor plate restraints. All floor plates will have some building loss, however the factor is only applicable when the loss can be measured or demonstrated to have a significant impact on the occupants space requirements. Typical building loss factors are excessive column size, curving walls, irregular or constrained floor plates which would require the occupant to require additional useable area in order to accommodate their functionally programmed requirements.

- Occupiable Area* The BCBC Useable area less the building loss factor. This represents the true area available for use by the occupant.
- Programmed Area* The area determined by space allocation standards to accommodate the occupants' functional requirements. The programmed area and occupiable area must be congruous in order to accommodate the occupants' functional requirements.

7.2 Circulation Space Factors

Circulation Space is calculated for all people spaces and enclosed support spaces. Open area support spaces have the area for circulation space included in the area allocation. The circulation space calculation is outlined in the table below.

Table 7: Circulation Allowance Calculations

Circulation Allowances	m²	ft²
Open Area Workstations	3.25 ea	35.0 ea
Enclosed Areas 16.7m ² or less	2.30 ea	25.0 ea
Enclosed Areas more than 16.7m ²	16% of EA	16% of EA
<i>For exit, egress requirements and circulation corridor widths, refer to the "British Columbia Building Code" and the "British Columbia Fire Code".</i>		

7.3 Determining the Building Loss Factor

The building loss factor is the percentage of the useable area that is unavailable for use by the occupant to house furniture or personnel due to significant building impediments and/or floor plate restraints. All floor plates will have some building loss, however the factor is only applicable when the loss can be demonstrated to have a measurable or significant impact on the occupants' space requirements. The Building loss factor can only be determined if the floor plate area is known.

A significant Building Loss Factor requires that the occupant either reduce the space program or acquire additional useable area to compensate for the loss.

Table 8: Determining Building Loss Factors

Determine Loss Areas	
Standard building loss factor to allow for elevator corridor, washroom and exit corridors and entry vestibule etc.	5% or measure the actual area if building is known. <i>Note:</i> <i>If the building has been entered into the BCBC space inventory the space will be listed as a multiple tenant occupancy and as such the major building loss factors shown in the adjacent column will have been deducted from the useable area. In this case the standard 5% factor is to be deleted and the actual useable to rentable factor applied.</i>
Excessive depth from face of wall to glazing due to window ledge or heating convector.	Determine the area lost.
Shear Walls	Determine the area lost.
Excessive column sizes - e.g. over .2 m ²	Determine the area lost.
Curving or significantly irregular walls	Determine the amount of floor area affected: Over 0% to under 20% of the floor affected <i>Add 1%</i> 20% to under 40% of the floor affected <i>Add 2%</i> 40% to under 60% of the floor affected <i>Add 3%</i> over 60% of the floor affected <i>Add 5%</i>
Other building inefficiencies or irregularities which with the approval of the accommodation planner can be demonstrated and measured to illustrate the loss in useable area.	Demonstrate and determine the area lost.
Determine Building Loss Factor	Sum the above losses and divide by the Useable Area to yield the Building Loss Factor.

7.4 Application of Mark-up Factors

The markup factors set out in the table below apply only to office buildings or buildings that are predominantly used as offices.

Table 9: Markup Factors

Programmed Area	Programmed Area to Useable Area Multiplier
Programmed area (standard building loss factor unless otherwise known)	5% default or as measured. <i>Refer to table 8.</i>
Useable Area	Useable Area to Rentable Area Multiplier
Partial floor, full floor or multi floor occupancy	10% default or as measured, or as defined in the BCBC space inventory. <i>Refer to table 8.</i>

----- end of section 7 -----

A.1 Glossary

Accommodation Planning	A department within the Customer & Portfolio Services Group of the BCBC, responsible for maintaining the <i>Government Office Space Standards</i> .
Accommodation Proposal (AP)	A document prepared by BCBC, responding to a Client's request for accommodation, containing an outline of proposed accommodation it is proposing to provide to the Client.
Building Common Support Space	A space allowance for support facilities that are shared by all groups within the facility. These include such areas as Main Building Reception, Security Room, Mailroom, large meeting facilities and training rooms, etc. Building common spaces may be located on any floor of the building. (May be referred to as Building Common Areas)
Building Loss Factor	Useable area that is not available for use by the occupant to house furniture or personnel due to significant building impediments and or floor plate restraints. All floor plates will have some building loss, however the factor is only applicable when the loss can be measured or demonstrated to have a significant impact on the occupants space requirements. Common building loss factors are excessive column size, curving walls, irregular or constrained floor plates which would require the occupant to require additional useable area in order to accommodate their functionally programmed requirements.
Circulation Area	Space allowances for the areas between landscaped office workstations, semi-enclosed areas, enclosed areas, other enclosed spaces, open work areas, and support spaces. This area is a derived from the space requirements.
Client	A Ministry, a designated Ministry branch, or other provincial government organization, which is fiscally responsible for accommodation and related service requirements provided by BCBC. Generally excluded are outside agencies or subtenants of the client.
Dedicated Support Space	A space allowance for files, equipment, storage, etc., that is shared with and/or for the benefit of others and must be located adjacent to the individual's workplace.
Enclosed Area (EA)	Enclosed areas with full height partitions, floor to ceiling (suspended or structural), used for an office, secure file room, meeting room, etc.
Facilities Program	A statement in written and graphic form that defines the criteria for the design of a facility, at a particular point in time.
Floor Common Support Space	A space allowance for support facilities that are shared by all groups on the floor(s).
Floor or Building Rentable Area	A measure of all internal space on a floor or floors of a building, excluding vertical penetrations. It is used in lease agreements. It may be calculated by measuring the actual or proposed space for rent, or, by marking up a required useable area by a percentage factor or multiplier. In the former case the measurement will be in accordance with BOMA

	method of measurement. For a whole building the Rentable Area is measured to the inside of exterior walls. The factor or multiplier will vary according to the type of building and the type of tenancy, e.g., single tenant floor, multiple tenant floor, whole building, etc. Rentable Area remains constant for the life of a building unless additional area is constructed.
Group Support Space	A space allowance for files, equipment, storage, enclosed rooms, meeting areas etc., which is shared by a group of workers.
Integrated Workplace Strategies	An umbrella term that encompasses a holistic approach to accommodating work. This is done by not only looking at how and where people work but also the work process, technology and management policies that are required in order to achieve maximum utilization of personnel, facilities and all other resources to achieve the greatest return on the investment.
Mark-up Factors	Varying percentages that are used to calculate Rentable or Useable Areas from a Programmed Area. These percentages allow for functional areas such as washrooms, utility service rooms, external walls, etc.
Occupiable or Programmable Area	The BCBC Useable Area less the building loss factor that is the true area available for use by the occupant.
Open Area (OA)	Office space in open area, allocations for workstations are expressed in unit areas of space, exclusive of circulation area, group storage areas, other areas on and off floor and mark-up factors. The unit areas are based on the actual space required with furniture for a particular function plus access from the circulation routes.
Program Area	The area determined by <i>Government Office Space Standards (GOSS)</i> required to functionally accommodate the occupants' requirements. The Programmed Area and Occupiable Area should be congruent in order to accommodate the occupants' requirements.
People Spaces	The area determined by <i>Government Office Space Standards</i> required to functionally accommodate people at their individual workspace.
Remote Support Space	Support space located off-site or at a remote location, records, storage meeting rooms, training facilities etc.
Request for Proposals (RFP)	Accommodation procurement document that detail specific requirements for project space, used mainly for the procurement of leased space.
Semi-Enclosed (SA)	Area enclosed with high screen partitions stopping short of the ceiling, thereby providing more privacy than an open area and greater flexibility than an enclosed space. High screen partitions may be used for workstations, meeting room, or other purposes.

Space Allocations	Allocation of floor area to accommodate individual people or groups, or specific furniture and equipment so that a particular function can be performed.
Space Program	A statement in written and graphic form, similar to a Facilities Program, but limited to a definition of required areas and their use.
Special spaces	A specialized support space such as laboratories, libraries, hearing rooms that would not normally be considered as part of office space. May be On-floor or Off-floor space.
Support Space	Allocation of space for functional areas, such as Filing, Printers, Mail area, Copiers, Break Areas, Meeting Rooms, Reception Areas, Main Building Reception, Security Room, Mailroom, etc. Allocations are expressed in unit areas of space similar to the "Open Space Workstations" and allocations may be Open Spaces (OS) or Enclosed Spaces (ES).
Technical Standards (TS)	A document that details acceptable life-cycle cost-based performance, materials and systems for BCBC procured accommodation. The Technical Standards are revised annually.
Technical Standards Steering Committee	A committee, reporting to Client Panel, comprised of ministry and BCBC representatives, that has overall veto or approval for the content of the Technical Standards
Technical Value Department	A department of the Customer & Portfolio Services Group of BCBC responsible for initiating changes to and providing maintenance of the Technical Standards.
Useable Area	<p>As per BCBC standard, is a measurement that comprises the rentable area of a floor less the service rooms and floor common area. Common area is floor area that is not under the occupants' control and available to house furniture, personnel, or space required by fire code and/or other restrictions, and is therefore considered non-useable.</p> <p>As per BOMA standard for a multi-floor tenancy is identical to BCBC Standard. However, for a single floor tenancy the useable area will generally include the lobby and service, life safety corridor.</p> <p>Useable area under both BOMA & BCBC definitions does however include columns, shear walls, heating convectors and generally window ledges. Useable area varies over the life of a building as the floor configurations vary and the floor common area is reconfigured.</p>

----- **end of Appendix A** -----

B.1 Ministry Specific or Program Standards

B.1.1 Contents

If a client Ministry wishes to use standards that vary from the space standards detailed in this manual, Ministry Specific or Program Space Standards can be developed.

B.1.2 Submission Procedures

The following outlines the procedure that should be followed in order to create specific or program standards:

- .1a Preferably, the Client requests the assistance of the Corporation in the development of the special standards, resulting in joint development of the special standard; or;
- .1b The Client submits draft specific or program standards to the Corporation to review for standards conformance.
- .2 In either case, the target is for an agreement to be reached so that the special standard:
 - .2a Either meets the standards set out in this manual; or,
 - .2b Contains variances to the standards set out in this manual. The variances are such that the Corporation and its client Ministry agree that these are functionally necessary for the proper delivery of the Ministry's operational program. In this case the Corporation will endorse the special standard and provide document to the Ministry.

----- *end of Appendix B* -----

C.1 Related Standards & Guidelines

- Technical Standards (Outlined below)
- Project Specific Standards (e.g., Courthouses)
- Handbooks (e.g., Tenant Improvements to Office Accommodation)
- Space Measurement Standards
- Master Request for Proposals

C.2 Relationship of Technical Standards to Space Standards

C.2.1 Purpose

The Technical Standards provide the technical requirements for BCBC owned or leased buildings. To be used by designers, these standards detail the kinds of systems and materials that are acceptable.

C.2.2 Development Process

The Technical Standards were developed through a Value Analysis process, with input from BC Government Ministry representatives, BCBC employees, and representatives from industry. All of the major solutions within the Technical Standards are based on Life Cycle Cost analysis of the alternatives.

C.2.3 Contents

The Technical Standards contain both performance criteria and prescriptive requirements. The Standards refer to appropriate parts of nationally and internationally recognized standards and specifications and required performance criteria.

The Technical Standards cover the following areas:

- Building Structure and Envelope including walls, windows and roofs.
- Interior Architecture including partitions, finishes, ceilings and millwork.
- Mechanical Systems including thermal environmental conditions, ventilation air, acoustic criteria, perimeter heating systems, zoning, controls and others.
- Electrical Systems including capacity, number of receptacles, and dedicated circuits.
- Lighting including illuminance levels, switching and controls, and standard luminaire types.
- Telephone and Data Cabling Systems that details the requirements for a structured cabling system.
- Building Fabric Security Upgrades that lays out choices for enhancements to base building.
- Landscaping including design guidelines, plant and tree selection, and irrigation requirements.
- Energy Standard that lays out how the province's commitment to the Draft National Energy Code for Buildings will be met.

C.2.4 Application

The Technical Standards are edited specifically for each project, based on a number of alternative choices for various systems. These choices depend on climate, location, building size and length of occupancy but they provide the same functionality. The edited Standards are attached to the Request for Proposal (RFP) in the case of leased space or the consultant agreement in the case of Corporate-owned space.

----- *end of Appendix C* -----

D.1 Application for Enclosed Office

The following form is provided as a reference guide and may be used by organizations/ministries to determine the requirement for an enclosed office.

Private offices may be provided for staff with senior management responsibilities (Director and above). All other staff enclosed office requirements must be approved by the Deputy Minister or designated signing authority. Further approval may be required by the Secretary to Treasury Board. ***This form is available in electronic format from BCBC Client and Accommodation Services.*

NAME: _____

POSITION: _____

CLASSIFICATION: _____

DIVISION: _____

GROUP/BRANCH: _____

CITY: _____

For the purpose of answering this questionnaire, do not include the following types of meetings or conversations: telephone calls; meetings that would normally occur away from the workstation (e.g. in meeting rooms, supervisors' or others' offices, field visits).

QUESTIONNAIRE

1. Please give a brief description of your responsibilities. Attach a separate sheet if necessary.

2. How many consultations do you have per week: _____ Duration: _____
3. How much prior notice is generally given to scheduled or random meetings?

	Scheduled	Random
0 - 3 Hours		
3 - 8 Hours		
1 - 2 Days		
3 - 5 Days		
1 Week or More		

4. Do the discussions of a financial or contractual/judicial nature involve any of the following:

	Check	Number / Week	Duration
Negotiations where financial gain or loss of participants could be involved.			
Discussion concerning negotiations where gain or loss to others is possible.			
Exchanges of CONFIDENTIAL information that would impede the privacy of others.			
Potential legal liability of parties to the discussion.			
Potential legal liability of parties external to the discussions.			

PLEASE EXPLAIN:

5. Are your discussions subject to Statutory Obligation of Confidentiality? (e.g. lawyer/client, not Public Service Oath)

YES____ NO____

6. Please indicate approximately percentage of meetings where:

- a. The affairs of the participants are the topic. _____%
- b. The affairs of persons external to the discussion are the topic. _____%

7. Who are potential 'overhearers'? Please explain risk/impact of occurrence.

Signature of Incumbent

APPROVALS:

DIRECTOR'S NAME (please print)

SIGNATURE

DATE

RECOMMENDED / NOT RECOMMENDED

ESTIMATED COST: \$ _____

COMMENTS:

FACILITIES MANAGER (please print)

SIGNATURE

DATE

DEPUTY MINISTER'S NAME (please print)

SIGNATURE

DATE

----- *end of Appendix D* -----

E.1 IWS References & Suggested Readings

- ❖ Carroll Thatcher Planning Group Inc, 1995.
- ❖ Herman Miller, Evolutionary Workplaces, Issues Report.
- ❖ TVA, Office Standards Program, Corporate Design and Development, September 18, 1992.
- ❖ *Toolkit – Reinventing the Workplace*. Becker, F., Cornell University; Joroff, M., MIT; Quinn, K.L., Cornell University.
- ❖ Becker, F., Rappaport, A.J., Quinn, K.L., and Sims, W.R. *Telework Centers: An Evaluation of the North American and Japanese Experience*. Ithaca, N.Y.: Cornell University International Workplace Studies Program, 1993.
- ❖ Joroff, M., and Becker, F. *Innovations in the Workplace: Process To Achieve Change*. Atlanta, Ga.: Industrial Development Research Foundation CRE 2000 Workplace Bulletin, 1994.
- ❖ Becker, F. *The Total Workplace: Facilities Management and the Elastic Organization*. New York: Van Nostrand Reinhold, 1990.
- ❖ Boyett, J.H., and Conn, H.P. *Workplace 2000: The Revolution Reshaping American Business*. New York: Dutton Press, 1991.
- ❖ Duffy, F. *The Changing Workplace*. London: Phaidon Press, 1992.
- ❖ “The New Workplace”. Business Week Cover Story, April 29, 1996.
- ❖ “Design as Organizational Catalyst”. Premises & Facilities, Sept. 1993.
- ❖ “State of the Workplace”. Becker, F., Premises & Facilities Management, March 1994.
- ❖ “How to Make the Most of Less Space”. Vischer, J., Globe and Mail, December 12, 1995.
- ❖ “The Ecology of New Ways of Working: Non-Territorial Offices”. Industrial Development Section, February 1993.
- ❖ “Redefining Work; Rethinking the Workplace”. Canadian Facility Management & Design, October 1995.

----- end of Appendix E -----

Figure 10: Rentable Area

Rentable Area = 2530 m²
BOMA or BCBC Measurement

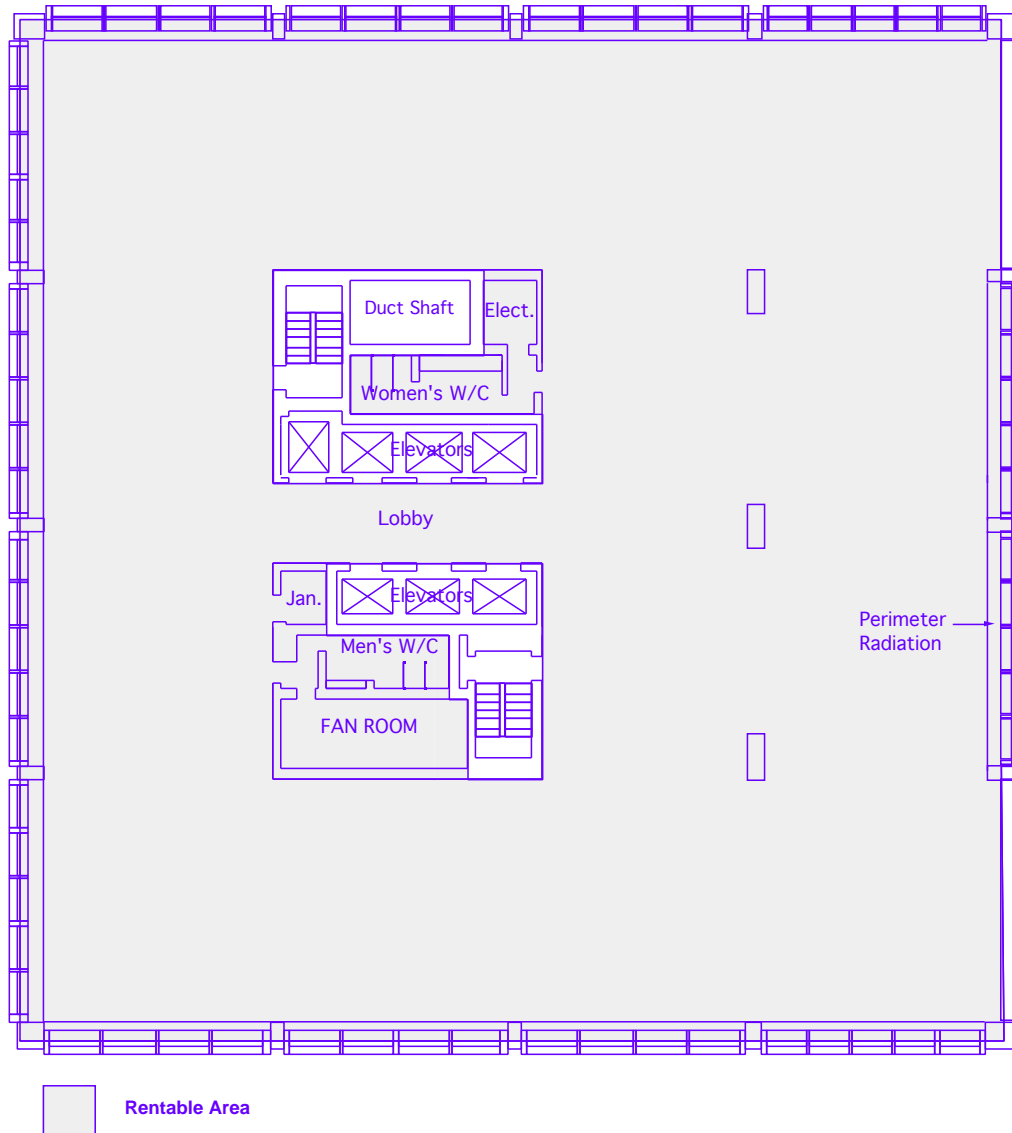

Figure 11: BOMA Useable Area – Single Tenancy

BOMA Useable Area = 2300 m²
Single Tenancy Occupancy

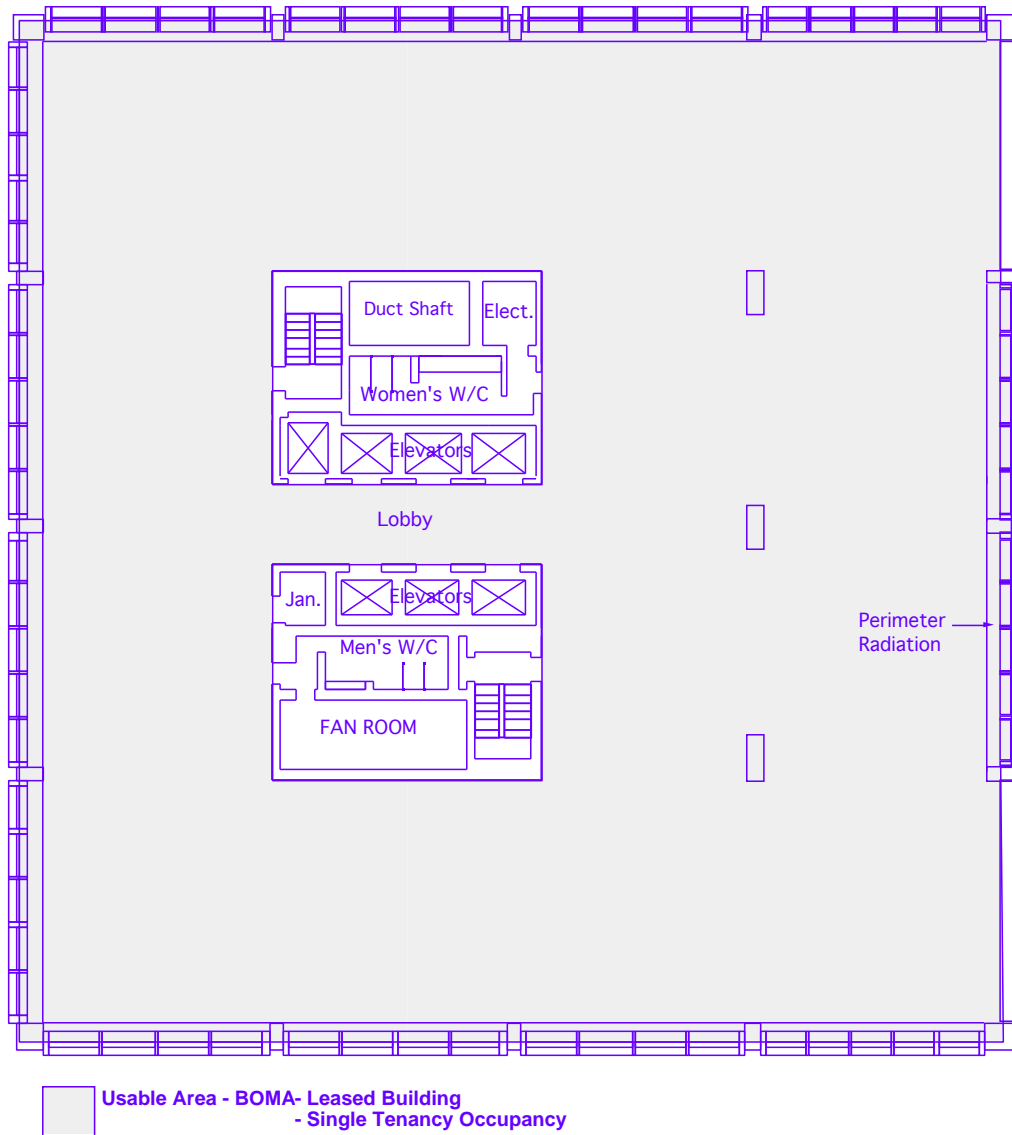

Figure 12: Occupiable

Occupiable Area = 2000 m²

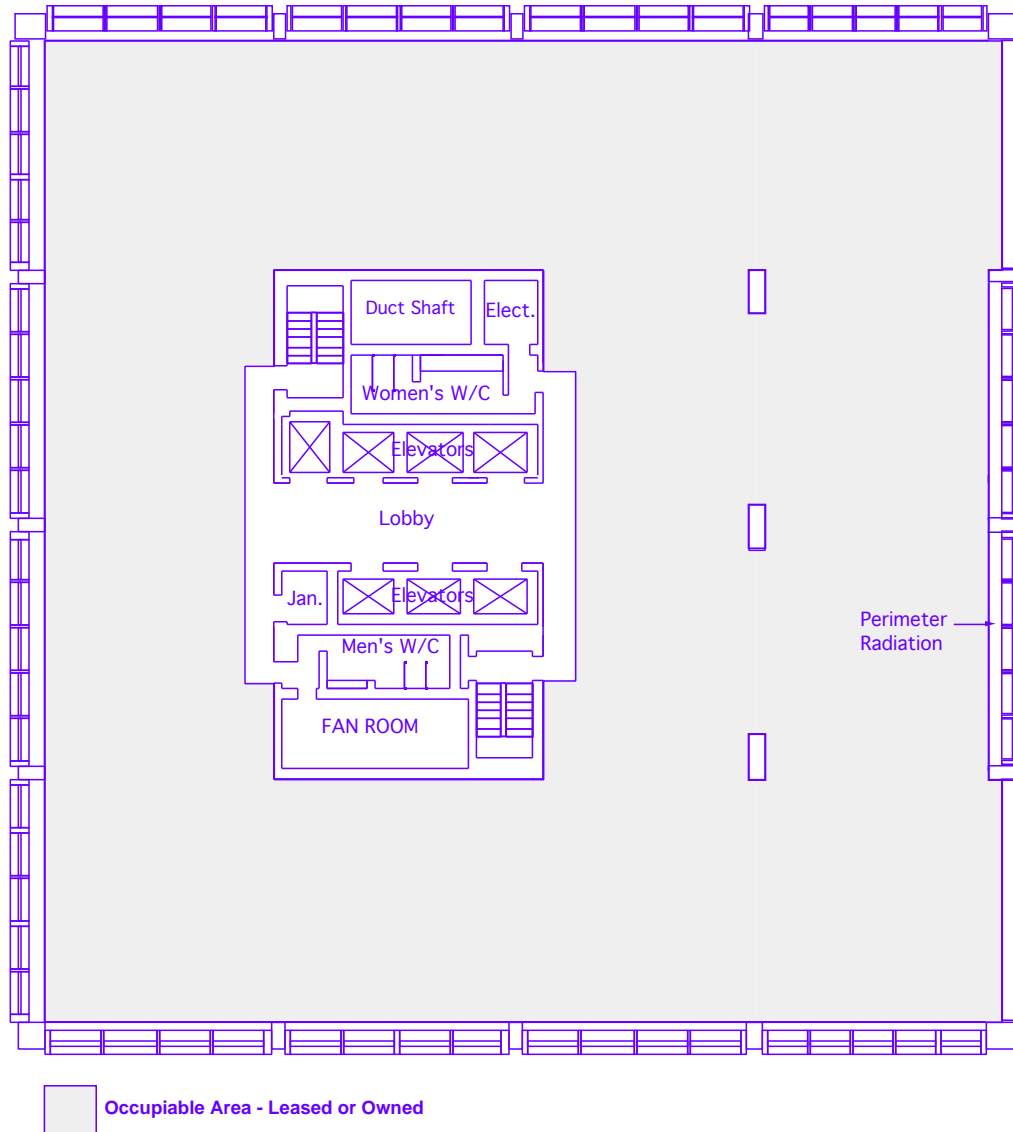
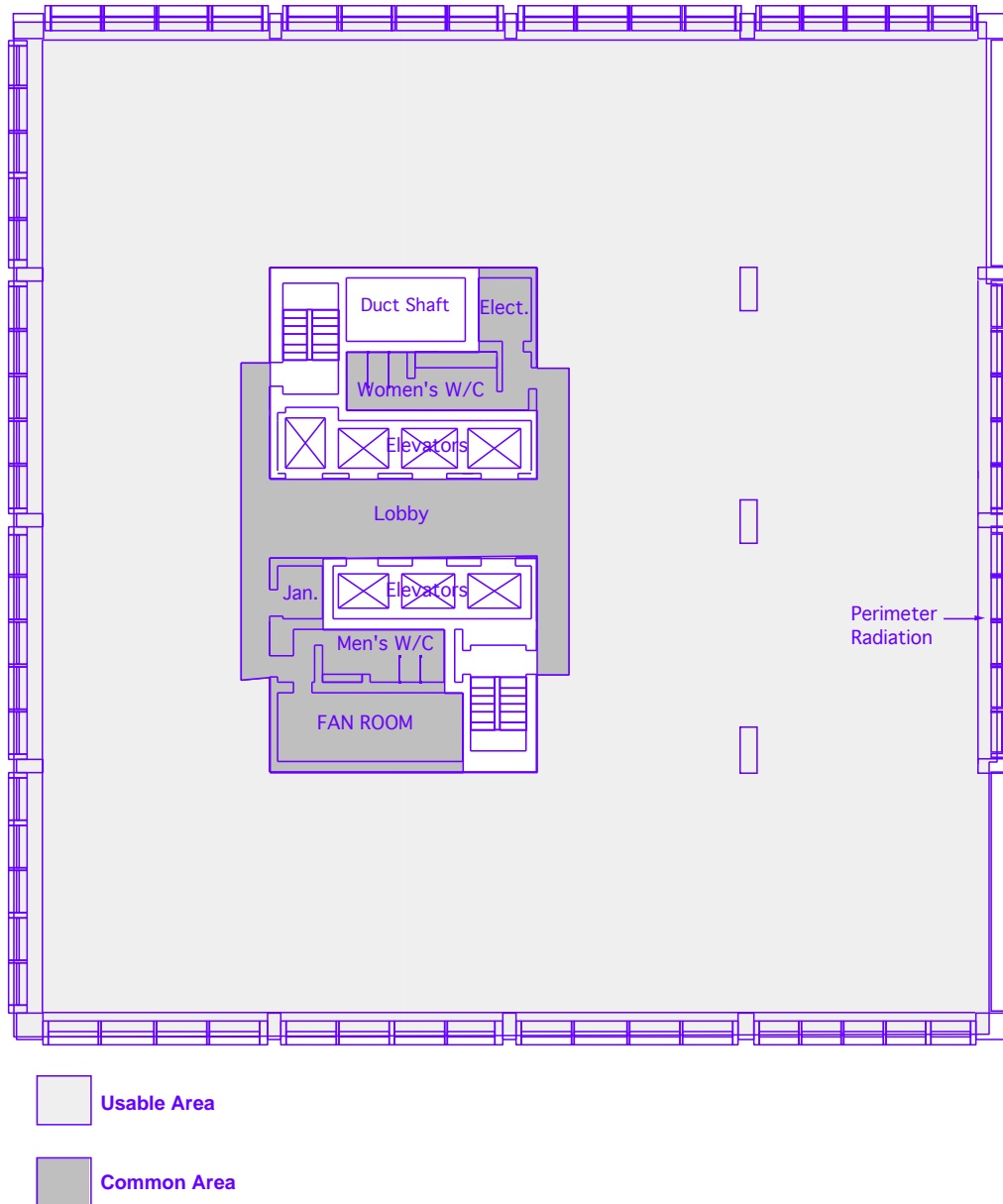

Figure 13: BCBC Useable Area – Multiple or Single Tenancy

BCBC Useable Area = 2200 m²
- Multiple or Single Tenancy

BOMA Useable Area = 2200 m²
- Multiple Tenancy

Common Area = 330 m²
(=Building Services 230 m² & Lobby & Corridor 100 m²)



----- end of Appendix F -----